

## FINAL REPORT

# Basis for a UMTS measurement recommendation

Project

**08R2-HFumts**

Commissioned by

**Swiss Agency for the Environment, Forests and Landscape**

Date

**30 April 2004**



### **SUPSI-DTI** **Alta Frequenza**

---

Galleria 2  
Via Cantonale  
CH-6928 Manno

Phone +41 91 610 85 31  
Fax +41 91 610 85 17

E-mail [hflab@supsi.ch](mailto:hflab@supsi.ch)

VAT 425.112

### **Project leader - SUPSI**

Eng. Andrea Salvadè  
Scuola Universitaria Professionale della Svizzera Italiana  
Alta Frequenza  
Galleria 2  
CH - 6928 Manno  
Phone: +41 91 610 85 37  
Fax : +41 91 610 85 17  
Email: asalvade@supsi.ch

### **Authors**

Eng. Andrea Salvadè  
Eng. Paola Guggiari  
Eng. Matteo Lanini  
Eng Tommaso Pagani  
Eng. Thomas Bartesaghi

### **Project leader - SAEFL**

Dr. Andreas Siegenthaler  
Swiss Agency for the Environment, Forests and Landscape  
Non-Ionizing Radiation Section  
CH - 3003 Bern  
Phone: +41 31 324 34 17  
Email: andreas.siegenthaler@buwal.admin.ch

**INDEX**

<b>1</b>	<b><u>INTRODUCTION</u></b>	<b>13</b>
<b>2</b>	<b><u>MANDATE FOR A STUDY "BASIS FOR A UMTS MEASUREMENT RECOMMENDATION" - SPECIFICATIONS</u></b>	<b>15</b>
2.1	POINT OF DEPARTURE	15
2.2	OBJECTIVE OF THE MANDATE	15
2.3	QUESTIONS TO BE TREATED	16
<b>3</b>	<b><u>MAIN CHARACTERISTICS OF WCDMA</u></b>	<b>17</b>
3.1	SPREAD SPECTRUM TECHNIQUE	17
3.2	DIRECT-SEQUENCE CDMA (DS-CDMA)	18
3.3	SPREADING AND SCRAMBLING CODES	20
3.3.1	ORTHOGONAL CODES	20
3.3.2	PSEUDO-NOISE CODES	21
3.4	SYNCHRONIZATION CODES	21
3.5	POWER CONTROL	21
3.6	DATA MODULATION	22
<b>4</b>	<b><u>UMTS SYSTEMS</u></b>	<b>24</b>
4.1	RAN ARCHITECTURE (RADIO ACCESS NETWORK)	25
4.2	EMITTED POWER AND FAST POWER CONTROL	26
4.3	FDD AND TDD	26
4.4	LOGICAL, TRANSPORT AND PHYSICAL CHANNEL	27
4.5	PHYSICAL CHANNELS CODING	28
4.5.1	CHANNELIZATION AND SCRAMBLING CODES FOR UTRAN	29
4.5.2	CPICH (COMMON PILOT CHANNEL)	30
4.5.3	CCPCH (COMMON CONTROL PHYSICAL CHANNEL)	31
4.5.4	SCH (SYNCHRONIZATION CHANNEL)	31
4.5.5	AICH (ACQUISITION INDICATOR CHANNEL)	31
4.5.6	PICH (PAGING INDICATOR CHANNEL)	31
4.5.7	DEDICATED CHANNELS	31
4.6	PLANNING AND MANAGEMENT OF THE UMTS NETWORK	32
4.6.1	CELLS STRUCTURE	32
4.6.2	CELL CAPACITY AND COVERAGE	32
4.6.3	WCDMA SYSTEM CAPACITY	35

<b>5</b>	<b>UMTS APPLICATION IN SWITZERLAND</b>	<b>38</b>
<b>5.1</b>	<b>FREQUENCY ATTRIBUTIONS</b>	<b>38</b>
<b>5.2</b>	<b>NETWORKS</b>	<b>39</b>
<b>6</b>	<b>COMMON USE</b>	<b>40</b>
<b>6.1</b>	<b>CONSEQUENCES ON THE MEASUREMENTS</b>	<b>40</b>
<b>7</b>	<b>MEASUREMENT METHODS PROPOSAL</b>	<b>42</b>
<b>7.1</b>	<b>ANALOGIES AND DIFFERENCES REGARDING GSM</b>	<b>42</b>
<b>7.2</b>	<b>STANDARD OPERATION</b>	<b>43</b>
7.2.1	FREQUENCY DOMAIN METHOD	43
7.2.2	SELECTIVE METHOD IN THE CODE DOMAIN	46
7.2.3	CALCULATION OF E AT THE MAXIMUM AUTHORIZED POWER	49
<b>7.3</b>	<b>INSERTION OF TEST SIGNALS FOR MEASUREMENT</b>	<b>50</b>
<b>8</b>	<b>INSTRUMENTS EVALUATION</b>	<b>51</b>
<b>8.1</b>	<b>ADVANTEST</b>	<b>52</b>
<b>8.2</b>	<b>ANRITSU</b>	<b>53</b>
<b>8.3</b>	<b>ROHDE&amp;SCHWARZ</b>	<b>54</b>
8.3.1	SOFTWARE ROMES WITH TEST RECEIVER R&S ESPI	54
8.3.2	SIGNAL ANALYZER R&S FSQ WITH WCDMA-3GPP OPTION	56
8.3.3	SPECTRUM ANALYZER R&S FSP WITH WCDMA-3GPP OPTION	57
8.3.4	SPECTRUM ANALYZER R&S FSU WITH WCDMA-3GPP OPTION	58
<b>8.4</b>	<b>TEKTRONIX</b>	<b>59</b>
<b>8.5</b>	<b>AGILENT</b>	<b>60</b>
8.5.1	AGILENT E7495A, BASE STATION TEST SET	60
8.5.2	AGILENT SPECTRUM ANALYZER ESA SERIE + EMSMOG CLAMPKO SYSTEM	61
8.5.3	AGILENT ESA-E SERIES SPECTRUM ANALYZERS E4402B + SOFTWARE FOR W-CDMA	62
8.5.4	AGILENT E6474A, WIRELESS NETWORK OPTIMIZATION PLATFORM	64
<b>8.6</b>	<b>MEASUREMENT DEVICES EVALUATION</b>	<b>64</b>
<b>8.7</b>	<b>INSTRUMENTS COMPARATIVE TABLE - GENERAL OVERVIEW</b>	<b>65</b>
<b>8.8</b>	<b>INSTRUMENTS COMPARATIVE TABLE - TECHNICAL SPECIFICATIONS</b>	<b>66</b>
<b>9</b>	<b>INTERNATIONAL RESEARCH</b>	<b>69</b>
<b>9.1</b>	<b>CONTACTS</b>	<b>69</b>

<b>10</b>	<b>MEASUREMENT OF UMTS SIGNALS</b>	<b>70</b>
<b>10.1</b>	<b>SPECTRAL MEASUREMENT</b>	<b>70</b>
<b>10.2</b>	<b>UMTS CHANNEL POWER MEASUREMENT</b>	<b>72</b>
<b>10.3</b>	<b>CPICH POWER MEASUREMENT IN THE CODE DOMAIN</b>	<b>73</b>
<b>10.4</b>	<b>MEASUREMENT EXAMPLES</b>	<b>74</b>
<b>11</b>	<b>MEASUREMENT OF UMTS SIGNALS IN THE LABORATORY</b>	<b>76</b>
<b>11.1</b>	<b>PURPOSE</b>	<b>76</b>
11.1.1	PRELIMINARY MEASUREMENTS	76
11.1.2	MAPPING THE FIELD DISTRIBUTION	76
11.1.3	<i>SCHWENKMETHODE</i> MEASUREMENTS	77
<b>11.2</b>	<b>SETTING UP A CONTROLLED LABORATORY FIELD PATTERN</b>	<b>78</b>
11.2.1	LABORATORY INSTRUMENTATION	78
11.2.2	FIELD STRENGTH MAPPING FOR A PURE SINE WAVE	78
11.2.3	INCIDENT AND REFLECTED FIELD STRENGTH OF A PURE SINE WAVE	79
11.2.4	UMTS SIGNAL MEASUREMENT IN THE FREQUENCY DOMAIN	81
<b>11.3</b>	<b>MAPPING OF THE FIELD PATTERN</b>	<b>83</b>
11.3.1	FIELD STRENGTH MAPPING OF A SYNTHETIC UMTS SIGNAL	83
11.3.2	PROFILES OF CPICH POWER ALONG HORIZONTAL AND VERTICAL LINES	83
11.3.3	REFERENCE MEASUREMENTS OF CPICH AND UMTS-CHANNEL POWER WITH A BICONICAL ANTENNA	86
11.3.4	REFERENCE MEASUREMENTS OF CPICH AND UMTS-CHANNEL POWER WITH A DIRECTIONAL ANTENNA	88
<b>11.4</b>	<b>MEASUREMENT OF THE CHARACTERIZED FIELD PATTERN WITH <i>SCHWENKMETHODE</i></b>	<b>88</b>
11.4.1	MEASUREMENT SCHEME	89
11.4.2	MEASUREMENT RESULTS	90
<b>11.5</b>	<b>REMARKS AND CONCLUSIONS ON THE FEASIBILITY OF THE <i>SCHWENKMETHODE</i></b>	<b>94</b>
<b>12</b>	<b>ON-SITE MEASUREMENTS</b>	<b>95</b>
<b>12.1</b>	<b>INSTALLATIONS</b>	<b>96</b>
12.1.1	BEFH INSTALLATION	97
12.1.2	ITTI INSTALLATION	98
12.1.3	BEGF INSTALLATION	100
12.1.4	KONI INSTALLATION	103
<b>12.2</b>	<b>COMPARISON OF DIFFERENT MEASUREMENT INSTRUMENTS</b>	<b>105</b>
12.2.1	PURPOSE	105
12.2.2	TYPES OF MEASUREMENT	105
12.2.3	RESULTS	105
12.2.4	CONCLUSIONS	108
<b>12.3</b>	<b>MEDIUM TERM REPRODUCIBILITY OF THE <i>SCHWENKMETHODE</i></b>	<b>109</b>
12.3.1	PURPOSE	109
12.3.2	METHOD	109
12.3.3	REPRODUCIBILITY AT BEFH	111
12.3.4	REPRODUCIBILITY AT ITTI	114
12.3.5	REPRODUCIBILITY AT BEGF	117

12.3.6	REPRODUCIBILITY AT KONI	120
12.3.7	OVERALL CONCLUSIONS ON REPRODUCIBILITY	123
<b>12.4</b>	<b>COMPARISON OF SPECTRAL MEASUREMENTS WITH DIFFERENT RESOLUTION BANDWIDTH</b>	<b>125</b>
12.4.1	PURPOSE	125
12.4.2	TYPES OF MEASUREMENT	125
12.4.3	RESULTS	126
<b>12.5</b>	<b>COMPARISON OF SPECTRAL AND UMTS CHANNEL POWER MEASUREMENTS</b>	<b>128</b>
12.5.1	PURPOSE	128
12.5.2	TYPES OF MEASUREMENT	128
12.5.3	RESULTS	128
<b>12.6</b>	<b>COMPARISON OF CPICH POWER AND UMTS CHANNEL POWER MEASUREMENTS</b>	<b>130</b>
12.6.1	PURPOSE	130
12.6.2	TYPES OF MEASUREMENT	130
12.6.3	RESULTS	130
12.6.4	CONCLUSIONS	133
<b>12.7</b>	<b>SHORT TERM REPRODUCIBILITY OF THE <i>SCHWENKMETHODE</i></b>	<b>134</b>
12.7.1	PURPOSE	134
12.7.2	TYPES OF MEASUREMENT	134
12.7.3	RESULTS	135
12.7.4	CONCLUSIONS	138
<b>13</b>	<b><u>SUMMARY AND CONCLUSIONS</u></b>	<b>139</b>
<b>14</b>	<b><u>THANKS</u></b>	<b>143</b>
<b>15</b>	<b><u>BIBLIOGRAPHY</u></b>	<b>144</b>

**LIST OF FIGURES**

figure 3-1: CDMA system	18
figure 3-2: Spreading/despreading of a signal	18
figure 3-3: The original signal can be recovered if the ratio $C/I$ is large enough	19
figure 3-4: The signal can not be recovered	19
figure 3-5: Narrowband interference resistance	20
figure 3-6: Spreading process	20
figure 3-7: Orthogonal codes tree	21
figure 4-1: TDD/FDD spectrum	24
figure 4-2: Core and Access Network	25
figure 4-3: FDD	26
figure 4-4: TDD	26
figure 4-5: UMTS channels/layers	27
figure 4-6: Downlink channels in FDD mode	27
figure 4-7: Downlink channels in TDD mode	28
figure 4-8: Channels coding	28
figure 4-9: Frame CPICH	30
figure 4-10: frame of downlink DPCH	32
figure 4-11: UMTS cells structure	32
figure 4-12: Maximum cell cover capacity	33
figure 4-13: Channels representation in the code domain	33
figure 4-14: Practical situations of cells use	34
figure 4-15: Softer handover	37
figure 4-16 Soft handover	37
figure 4-17 Hard handover sequence	37
figure 5-1: Frequency bands reserved for UMTS	38
figure 6-1: UMTS signal bandwidth	40
figure 6-2: Distance between different carriers	41
figure 7-1: Situation with two adjacent cells	43
figure 7-2: WCDMA spectrum with two cells	43
figure 7-3: Evaluation of the indicative measurement	45
figure 7-4: Measurement situations	47
figure 7-5: Scheme for the calculation of $E$ at the maximum authorized power	49
figure 10-1: Spectral measurement of a UMTS signal with RBW=1 MHz	71
figure 10-2: Spectral measurement of a UMTS signal with RBW=5 MHz	71
figure 10-3: Spectral measurement of 3 adjacent UMTS signals with RBW filter 5 MHz	71
figure 10-4: UMTS channel power measurement with R&S FSQ and 3GPP option (FS-K73)	72
figure 10-5: UMTS channel power measurement with Tektronix YBT250	72
figure 10-6: WCDMA spectrum with two cells	73
figure 10-7: Relative power measurement in code domain with Tektronix YBT250	74
figure 10-8: Absolute power measurement in code domain with Tektronix YBT250	74
figure 10-9: Code domain measurements with Anritsu ML8720B	75
figure 10-10: CPICH power measurement with R&S FSQ	75
figure 11-1: Laboratory setup	76
figure 11-2: <i>Schwenkmethode</i> within the test volume	77
figure 11-3: Minima and maxima measurement setup	78
figure 11-4: Field strength profile along the line shown in figure 11-3	79
figure 11-5: Minimum and maximum - measurement setup	79
figure 11-6: Experimental setup for measurement of incident and reflected power	80
figure 11-7: Direct and reflected wave measurement (S21 parameter)	80
figure 11-8: Measurement setup	81
figure 11-9: UMTS signal - 2 cells at different carrier frequency	82
figure 11-10: Distorted signal due to a reflection	82
figure 11-11: Measurement setup and coordinate system	83
figure 11-12: P-CPICH power measured along 3 horizontal lines in the absence of a reflecting panel	84
figure 11-13: P-CPICH power measured along 3 horizontal lines in the presence of a reflecting panel	84

figure 11-14: P-CPICH power measured along a vertical line in the presence of a reflecting panel	84
figure 11-15: Maxima/minima in front of a transmitter	85
figure 11-16: Measurement surface and biconical antenna orientation	86
figure 11-17: P-CPICH power measured at height $z = 10$ cm	86
figure 11-18: P-CPICH power measured at height $z = 30$ cm	87
figure 11-19: P-CPICH power measured at height $z = 50$ cm	87
figure 11-20: <i>Schwenkmethode</i> measurement setup	89
figure 11-21: <i>Schwenkmethode</i> , biconical antenna	89
figure 11-22: <i>Schwenkmethode</i> , directional antenna	89
figure 11-23: <i>Schwenkmethode</i> movement	90
figure 11-24: $P_{P\_CPICH}$ : deviation from global maximum; all data	91
figure 11-25: $P_{P\_CPICH}$ : deviation from global maximum; biconical antenna	91
figure 11-26: $P_{P\_CPICH}$ : deviation from global maximum; directional antenna, single polarization	91
figure 11-27: $P_{P\_CPICH}$ : deviation from global maximum; directional antenna, multiple polarizations	91
figure 11-28: $P_{channel}$ : deviation from global maximum; all data	92
figure 11-29: $P_{channel}$ : deviation from global maximum; biconical antenna	92
figure 11-30: $P_{channel}$ : deviation from global maximum; directional antenna, fixed polarization	92
figure 11-31: $P_{channel}$ : deviation from global maximum; directional antenna, multiple polarizations	92
figure 12-1: Coordinates system (tripod and antenna)	95
figure 12-2: <i>Schwenkmethode</i> measurement volume	96
figure 12-3: Map of the installations, town of Bern	96
figure 12-4: Map of BEFH installation	97
figure 12-5: View of the BEFH installation	97
figure 12-6: View of the point of measurement at BEFH	97
figure 12-7: Map of ITTI installation	98
figure 12-8: View of the ITTI installation	98
figure 12-9: View of the BUWAL building where the indoor measurements were performed	98
figure 12-10: Indoor view of the point of measurement	99
figure 12-11: View of the antenna at the point of measurement	99
figure 12-12: Map of the points of measurement	99
figure 12-13: Map of BEGF installation	100
figure 12-14: View of the BEGF installation	100
figure 12-15: View of the building where the indoor measurements were performed	100
figure 12-16: Map of the room	101
figure 12-17: Map of the indoor points of measurement	101
figure 12-18: View of an indoor point of measurement	101
figure 12-19: Map of the outdoor points of measurement	102
figure 12-20: View of the outdoor point of measurement	102
figure 12-21: Map of KONI installation	103
figure 12-22: View of the KONI installation	103
figure 12-23: View of the building where the indoor measurements were performed	103
figure 12-24: Map of the indoor points of measurement	104
figure 12-25: Map of the outdoor points of measurement	104
figure 12-26: View of the indoor points of measurement	104
figure 12-27: View of the outdoor points of measurement	104



**LIST OF TABLES**

table 4-1: Typical bitrate in UMTS bearer	24
table 4-2: Channels acronyms	28
table 4-3: Channelizations/scrambling codes	29
table 5-1: Frequency attribution for mobile communications operators	39
table 5-2: Coverage of the cells	39
table 10-1: Power of transmitted channels referred to PCPICH (source: Swiss network provider, Swisscom AG)	73
table 11-1: Global maximum and minimum values measured with the biconical antenna	87
table 11-2: Global maximum values measured with the directional antenna	88
table 11-3: Global maximum values measured on the grid inside the test volume	88
table 11-4: Equipment characteristics for testing the <i>Schwenkmethode</i>	88
table 11-5: Sampling rate (number of samples per meter of antenna movement; sa/m)	90
table 11-6: Maximum deviations obtained with the <i>Schwenkmethode</i>	94
table 12-1: Location of the installation BEFH	97
table 12-2: Technical data of the installation BEFH	97
table 12-3: Location of the ITTI installation	98
table 12-4: Technical data of the ITTI installation	98
table 12-5: Coordinates of the points of measurement	99
table 12-6: Location of the BEGF installation	100
table 12-7: Technical data of the BEGF installation	100
table 12-8: Coordinates of the indoor points of measurement	101
table 12-9: Coordinates of the outdoor point of measurement	102
table 12-10: Location of the KONI installation	103
table 12-11: Technical data of the KONI installation	103
table 12-12: Coordinates of the points of measurement	104
table 12-13: Instruments for spectral power measurements with RBW=5 MHz	105
table 12-14: Comparison of spectral power measurements with RBW=5 MHz (ITTI and BEGF) - brief	105
table 12-15: Instruments for UMTS channel power measurements	106
table 12-16: Comparison of UMTS channel power measurements (ITTI and BEGF) - brief	106
table 12-17: Instruments for code domain measurements	107
table 12-18: Comparison of CPICH power measurements - brief	107
table 12-19: Environmental conditions - BEFH	111
table 12-20: Summary of reproducibility measurements – at BEFH	113
table 12-21: Environmental conditions - ITTI	114
table 12-22: Summary of reproducibility measurements – at ITTI	116
table 12-23: Environmental conditions BEGF	117
table 12-24: Summary of reproducibility measurements – at BEGF	119
table 12-25: Influence of an increase of transmitted power on measured power levels (mean values)	119
table 12-26: Environmental conditions - KONI	120
table 12-27: Summary of reproducibility measurements – at KONI	122
table 12-28: Summary of standard deviations (dB)	123
table 12-29: Summary of daily variation ranges	124
table 12-30: Environmental situation - ITTI	126
table 12-31: Environmental situation - BEGF	126
table 12-32: Instruments and settings used	126
table 12-33: Comparison of spectral power measurements performed with RBW 1 MHz and RBW 5 MHz at ITTI and BEGF	127
table 12-34: Environmental situation - ITTI	128
table 12-35: Environmental situation - BEGF	128
table 12-36: Instruments and settings used	128
table 12-37: Comparison of spectral and UMTS channel power measurements at ITTI and BEGF	129
table 12-38: Environmental conditions - ITTI	130
table 12-39: Environmental conditions - BEGF	130
table 12-40: Environmental conditions - KONI	131
table 12-41: Instruments used	131
table 12-42: Difference between UMTS channel power (instr#C) and the power of all common channels derived from CPICH measurements	132

table 12-43: Difference between UMTS channel power (instr#D and instr#E) and the power of all common channels derived from CPICH measurements	132
table 12-44: <i>Schwenkmethode</i> - instruments and settings used for spectral and UMTS channel power measurements at ITTI and BEGF	135
table 12-45: <i>Schwenkmethode</i> - points of measurement for spectral and UMTS channel power measurements	135
table 12-46: ITTI point 2, indoor - brief (values in brackets are standard deviations of 4 individual measurements)	135
table 12-47: BEGF point 1, indoor - brief (values in brackets are standard deviations of 4 to 6 individual measurements)	136
table 12-48: BEGF point 1, outdoor – brief (values in brackets are standard deviations of 6 individual measurements)	136
table 12-49: <i>Schwenkmethode</i> - instruments used for UMTS channel and CPICH power measurements	137
table 12-50: <i>Schwenkmethode</i> - points of measurement for UMTS channel and CPICH power measurements	137
table 12-51: BEGF point 3, indoor - brief (values in brackets are standard deviations of 6 individual measurements)	137
table 12-52: BEGF point 2, outdoor - brief (values in brackets are standard deviations of 6 individual measurements)	137
table 12-53: KONI point 1, outdoor - brief (values in brackets are standard deviations of 4 individual measurements)	137
table 12-54: Difference between <i>Schwenkmethode</i> and fixed point measurements - brief (reference: fixed point measurement)	138
table 12-55: Difference between <i>Schwenkmethode</i> and fixed point measurements, aggregated from table 12-54	138

**LIST OF ACRONYMS**

3GPP	Third Generation Partnership Project (initiative)
CD	Code Domain
DTI	Department of Innovative Technologies
FD	Frequency Domain
ITU	International Communication Union
MAC	Media Access Layer
RLC	Radio Link Control
RRC	Radio Resource Control
SUPSI	Scuola Universitaria Professionale della Svizzera Italiana
UE	User Equipment
UMTS	Universal Mobile Telecommunication System
UTRA	UMTS Terrestrial Radio Access
UTRAN	UMTS Terrestrial Radio Access Network

## **ABSTRACT**

*The University of Applied Sciences of Southern Switzerland (SUPSI) received mandate from the Swiss Agency for the Environment, Forests and Landscape (SAEFL - BUWAL) for the study of a measurement method for electromagnetic fields (EMF) around UMTS base stations.*

*UMTS stands for Universal Mobile Telecommunication System and represents an evolution of the second generation mobile network (GSM): indeed it's called third generation (3G). Thanks to its high data rate, the new generation offers many services like videoconferencing, internet access and many other services. High speed transmission is possible thanks to the WCDMA technique (Wideband Code Division Multiple Access).*

*The transmission technology used in 3G terminals exploits the frequency spectrum in a different way than GSM networks. Then the measurement protocol of EMF for GSM base stations is not available for UMTS technologies.*

*The project has been divided in two phases: the first phase is dedicated to the acquisition of knowledge on 3G technology, to the study of the possible measuring methods for the UMTS signal and the evaluation of the measuring instruments, while the second phase is dedicated to the practical part of the project where the proposed methods have been tested in laboratory and on field.*

*The first phase of the project was performed in three main areas: theoretical study of the UMTS signal, development and evaluation of measuring methods, evaluation of the available instrumentation for WCDMA signals.*

*The theoretical study of the UMTS technology clarified the behavior of UMTS channels in the frequency domain and in the code domain. The UMTS in the Swiss network has been verified as well.*

*Different proposals for measurement protocol have been developed so as to allow the measurement of the nominal and of the maximal power of a UMTS cell.*

*A first method identified is the wideband measurement performed without any WCDMA signal decoding. This method allows to evaluate if the electric field of a cell is well under the permitted limit with a simple measurement. The method is quite simple but gives just approximated values.*

*A second method, based on decoded WCDMA signals, gives a better evaluation because the measurement is focused on signals of a single cell.*

*The second phase of the project was divided into two main areas: UMTS signal measurement in the laboratory and on the field.*

*The laboratory measurement clarified the signal conduct in an environment with signal reflections. Afterwards, it was tested if the "Schwenkmethode" could be applied to UMTS signals.*

*During the on field measurements, many trials were performed, i.e. evaluation of the influence of the RBW filter in a measurement with a spectrum analyzer and evaluation of measurements in the frequency domain vs. measurements in the code domain.*

*The measurements were performed on Swisscom AG installations, where there was few, or no active traffic channels. This means that the measurements practically concerns common channels.*

## 1 INTRODUCTION

The University of Applied Sciences of Southern Switzerland (SUPSI) received mandate from the Swiss Agency for the Environment, Forests and Landscape (SAEFL - BUWAL) for the study of a measurement methodology for signals emitted by UMTS (Universal Mobile Telecommunications System) base stations.

This study has been divided in two phases. The aim of the first phase was the know-how acquisition of the new UMTS technology, the study of the measurement methodologies and the research of the state-of-the-art instrumentation available for the WCDMA technique (Wideband Code Division Multiple Access). The second phase is focused on the measurement methods evaluation through laboratory and field measurements.

The report deals with the different aspects of the UMTS channel coding and modulation for the FDD (Frequency Division Duplex) transmission in downlink communication modality. Some hints to the TDD (Time Division Multiplex) modality are also given, even if for these modality no measurement method has been proposed: TDD uses a kind of modulation which is very different from the FDD. Anyway, Swiss operators are not foreseeing its implementation in the medium term.

For the FDD modality, we propose two measurement typologies in the frequency and code domain.

In the frequency domain, it is possible to make an approximate estimation of the maximum electric field of one cell: it is a simple measurement executed on a window (up to the whole) cell frequency bandwidth (5MHz). This measurement doesn't need special measurement devices for the WCDMA technique, but the signal contains other cells contributions, which are sharing the same frequency bandwidth. The aim of this indicative measurement is to verify if it is necessary a measurement in the code domain.

In the code domain instead, it is possible to execute a measurement aimed on the specific contribution of a cell and it is then possible to evaluate the maximum electric field emitted from a cell: the measurement is executed on the full cell frequency bandwidth (5 MHz), with signal decoding. This measurement needs devices dedicated to the decoding of the WCDMA signal.

Chapter 2 explains the general objectives of the mandate are described.

Chapter 3 introduces the WCDMA technique, which is the modulation used in the UMTS technology. The chapter will explain the spreading, scrambling and channels modulation concepts.

Chapter 4 describes the UMTS system and the WCDMA technique. The available UMTS channels will be also described and some practical cases are reported.

Chapter 5 deals with the Swiss UMTS network implementation. The description of the frequency bandwidth distribution to the operators, the network status and the forecasting of the planning for the future, is given.

Chapters 6 and 7 are dedicated to the possible measurement methodologies. At first, some considerations about the "multi-use" of the installations, where several operators or different technologies are present. Finally, the two proposed measurement methods are considered in detail: frequency and code domain measurements.

Chapter 8 concerns the research done on the measurement devices dedicated to UMTS signals. Advantages and drawbacks of the devices, which have been already tested and will be also tested in the laboratory and on the field in the second phase, are listed.

Chapter 9 illustrates the international contacts with researchers active in the scope of the UMTS signals measurement. Collaboration proposals on this project are also discussed.

Chapter 10 explains the different measurement typologies performed during laboratory and field measurements. Examples of some instrument reports are shown as well.

Chapter 11 concerns laboratory measurements. Trials were performed with a setup similar to a real environment: reflections in order to produce field strength minima/maxima. These trials also permitted to determine that the *Schwenkmethode* is applicable to UMTS signals, too. Measurements have been performed with different instruments.

Chapter 12 is dedicated to the field trials. We performed instrument comparisons, measurements with different RBW filters and finally measurements in frequency/code domain. The first evaluation of each comparison and measurement series are given in this chapter.

## **2 MANDATE FOR A STUDY "BASIS FOR A UMTS MEASUREMENT RECOMMENDATION" - SPECIFICATIONS**

### **2.1 POINT OF DEPARTURE**

The Ordinance relating to Protection from Non-Ionizing Radiation (ONIR) assigns to the Swiss Agency for the Environment, Forests and Landscape (SAEFL) the task of recommending suitable measurement and calculation procedures which allow the enforcement authorities to control compliance with the installation limit values (article 12 paragraph 2 ONIR). In a first step SAEFL has published two recommendations in June 2002:

- Mobile telecommunication and WLL base stations - recommendation for the enforcement of the ONIR
- Mobile telecommunication base stations (GSM) - measurement recommendation (jointly published with METAS).

In the next months and years at least 3 UMTS networks will be set up in Switzerland. Some hundred UMTS installations have already been authorized, several thousands are likely to follow. While the enforcement recommendation (see above) is applicable to UMTS installations too, a specific recommendation for the measurement of UMTS radiation has still to be elaborated.

The following basic principles, which were laid down in the already published recommendations, are also valid for UMTS measurements:

- Indoor the spatial maximum of the field strength has to be determined.
- It is desirable to apply the same method for searching the spatial maximum as in GSM measurements (so called *Schwenkmethode*).
- The measurement uncertainty is neither added nor subtracted.
- The result of a measurement must refer to the operation of the installation at its maximum speech and data traffic at maximum transmission power (Appendix 1 number 63 ONIR).

### **2.2 OBJECTIVE OF THE MANDATE**

The mandate shall provide the basics on which SAEFL and METAS can build a UMTS measurement recommendation.

Specific properties of the UMTS system with regard to transmission parameters and measurement technology shall be analyzed. Proposals for one or several measurement procedures shall be elaborated and tested in pilot trials. The measurement procedures must satisfy the requirements set in the ONIR, i.e. the rms value of the electric field strength must be measured and it must be possible to extrapolate the measured value to the maximum transmission power.

There are basically two measurement procedures which can be considered. Both are to be worked out and to be compared with respect to their outcome:

- measurement of the installation during its real operation, making use of the inherent properties of the system and doing without special parameter settings.
- measurement of the installation in a artificial state of operation (e.g. by using a simple substitute signal according to the proposal of SICTA<sup>1</sup>).

---

<sup>1</sup> "Ermittlung der Immissionen und Ueberprüfung der NISV-Grenzwerte bei Mobilfunknetzen, Kap. 5.6.7; SICTA 2001

## 2.3 QUESTIONS TO BE TREATED

### Preliminary investigations

- Analysis of the radio parameters specific to UMTS signals which are important for the measurement of NIR (specifically the properties of the common pilot channel, the temporal variability of UMTS signals, the bandwidth and modulation of the signal as well as feasible artificial states of operation).
- Analysis of the consequences for the UMTS signals to be measured which result from the common use of transmission installations by several network operators as permitted by the ComCom.
- International search for approaches of UMTS measurements
- Proposal of one or several measurement procedures under real operation of the installation
- Proposal of a suitable artificial state of operation together with the respective measurement procedure
- Evaluation of measurement instruments

### Main study

Testing of the proposed measurement procedures at real or test installations with own or rented measurement instruments. The following aspects require specific attention:

- Determination of the power or field strength of the common pilot channels relative to the total signal
- Measurements using various types of instruments or decoding systems.
- Testing the feasibility of procedures for searching the local maximum
- Validation of the extrapolation procedure



### 3 **MAIN CHARACTERISTICS OF WCDMA**

WCDMA (Wideband Code Division Multiple Access) is a technique developed for wideband digital telecommunications systems. WCDMA is employed for 3G mobiles because it provides higher data rates than previous generations. WCDMA offers new services for mobile communications: apart from voice transmission, the third generation protocols allows picture transmission, data transmission and videoconferences. WCDMA supports well the concept of Bandwidth on Demand (BoD) for services which need highly variables data rates.

WCDMA uses a bandwidth of 5 MHz and supports very high bit rates up to 2 Mbps in smaller cells (384 kbps in wider cells). The high transmission speed is reached thanks to the spreading technique DS-SS-CDMA (direct sequence CDMA).

#### 3.1 **SPREAD SPECTRUM TECHNIQUE**

Spread spectrum (SS) transmission is a technique in which the original signal is transformed into another form that occupies a larger bandwidth than the original signal would normally need. This transformation (known as spreading) offers several good properties in telecommunications systems:

- *multiple access capability*: several users can communicate simultaneously in the same frequency band;
- *protection against multipath interference*: a signal that is transmitted is subjected to delays, reflections and diffractions on the path; a spread-spectrum CDMA signal can resist the multipath interference if the spreading codes used have good autocorrelation properties;
- *good jamming resistance*: because the power spectral density of the signal is so low and resembles background noise, it is difficult to detect and jam on purpose;
- *privacy*: it is impossible to recover the original signal if you do not know the right spreading code and you are not synchronized to it;
- *narrowband interference resistance*: while the demodulation process despreads (recovers) the original signal, it also spreads the interfering signal.

Note that a wideband carrier does not increase the capacity of the allocated bandwidth as such, however the signals are more resistant to intercell interference and thus it is possible to reuse the same frequency in adjacent cells (frequency reuse factor is 1). In typical GSM systems the value is at least 4.

### 3.2 DIRECT-SEQUENCE CDMA (DS-CDMA)

In a DS-CDMA system all users occupy the same frequency and their signals are separated from the others by means of a special code (figure 3-1).

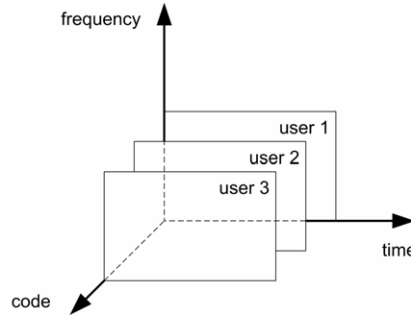

figure 3-1: CDMA system

In the spreading technique the original data sequence is multiplied (XOR) with a spreading code which typically has a much larger bandwidth than the original signal. The result of the operation is a signal containing all the initial information but having a bandwidth similar to that of the spreading code (figure 3-2 above).

During demodulation, multiplying once more the wideband signal with the same spreading sequence recreates the original signal. This is possible only if during the despreading sequence the signal is synchronized to the spreading code, otherwise data can not be recovered. (figure 3-2 low).

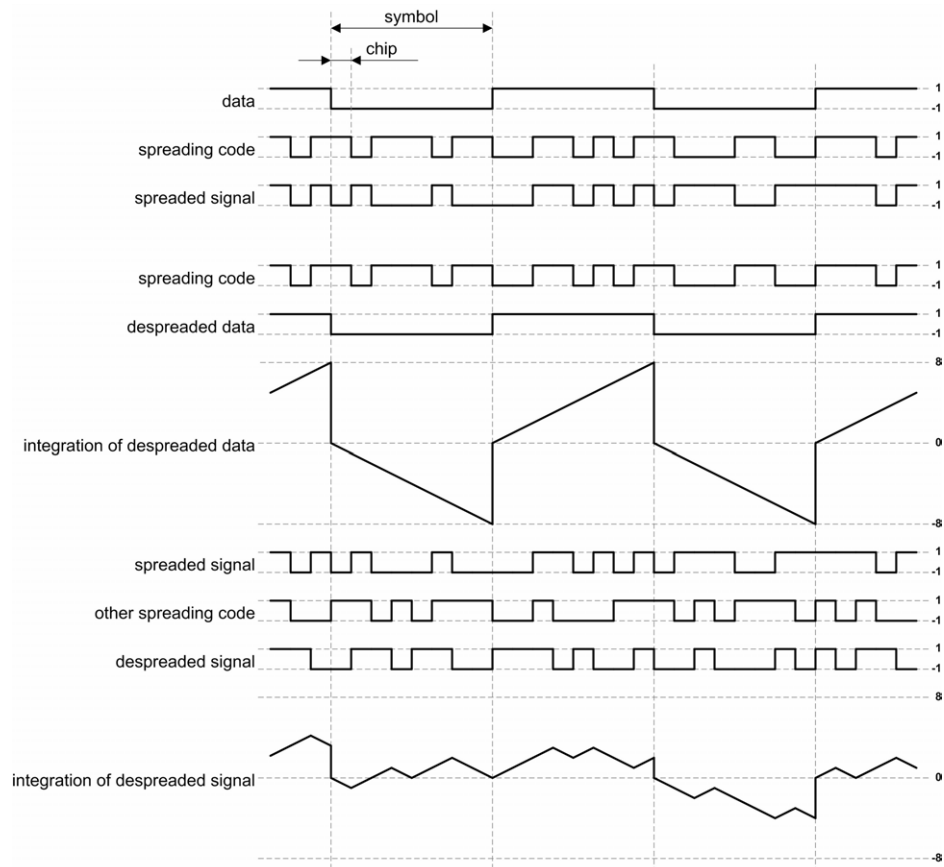

figure 3-2: Spreading/despreading of a signal

The bits in the spreading code are called “chips” to differentiate them from the bits in the data sequence, which are called “symbols”.

Each user has its own spreading code. The chip rate of the code must be higher than the bit rate of the signal. The ratio between the chip rate and data rate is known as Spreading Factor (SF).

After despreading the amplitude of the signal increases in comparison with the CDMA signal: this effect is termed “processing gain”.

Processing gain is what gives CDMA systems the robustness against the interference given by other channels modulated over the same carrier (synchronized and with different spreading sequences).

If during the signal (data) modulation orthogonal spreading codes are used, that is they have a low cross-correlation, the signals obtained do not interfere to each other. This implies that several wideband signals can coexist on the same frequency without severe mutual interference. It must be considered that the original signal can be recovered in the receiver as long as the power of the despreaded signal is a few dBs higher than the interfering noise power.(figure 3-3); that is the carrier-to-interference ratio has to be large enough. For this reason the number of users who may use a frequency band is limited. The carrier-to interference ratio is denoted by C/I.

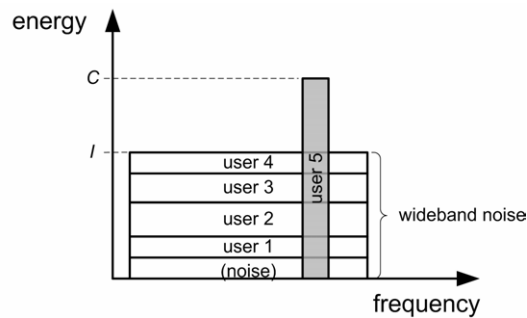

figure 3-3: The original signal can be recovered if the ratio C/I is large enough

An excessive load, that is an excessive number of users in the cell, may generate too much interference and compromise the despreading: the recover of the signal becomes impossible (figure 3-4).

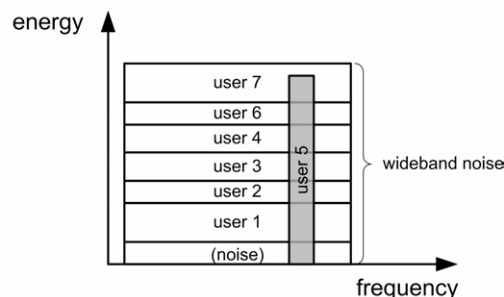

figure 3-4: The signal can not be recovered

After despreading the original signal can be recovered, while spreading the noise peaks (figure 3-5); this is the reason for the narrowband interference resistance of this kind of coding.

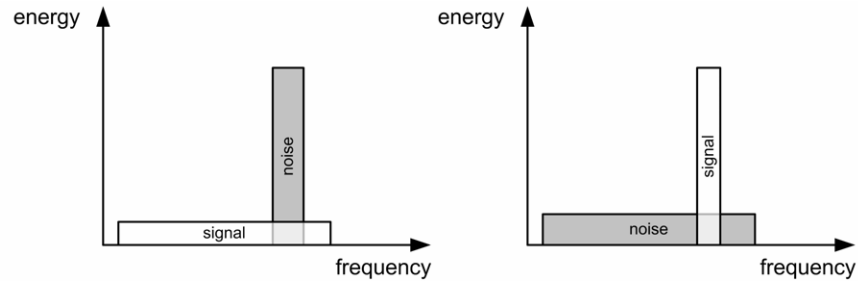

figure 3-5: Narrowband interference resistance

### 3.3 SPREADING AND SCRAMBLING CODES

In UMTS technique the coding process provides two phases: the spreading and the scrambling (figure 3-6). The spreading phase is also known as channelization. Both of them are used together in uplink and in downlink.

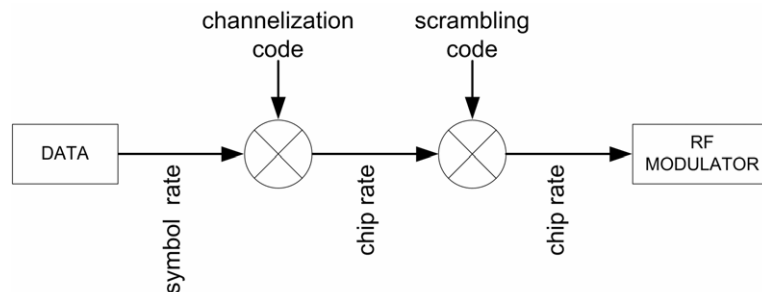

figure 3-6: Spreading process

The channelization process, that occurs before scrambling in the transmitter, uses orthogonal codes whereas scrambling process uses pseudo-noise codes.

The spreading expand the bandwidth of the original signal in order to share the frequency band with other users/services that have to use synchronized orthogonal codes.

The scrambling does not modify the signal bandwidth but is used to separate terminals and cells: it makes the channel independent from the orthogonal codes synchronization.

#### 3.3.1 ORTHOGONAL CODES

A transmitter separates his channels using the channelization process with orthogonal codes (OVSF technique - Orthogonal Variable Spreading Factor), meaning that in an ideal environment they don't interfere with each other.

The use of OVSF codes allows the spreading factor to be changed and orthogonality between different spreading codes of different length to be maintained.

The number of codes comes from a tree structure, the branches of this tree limits the spreading factor (figure 3-1).

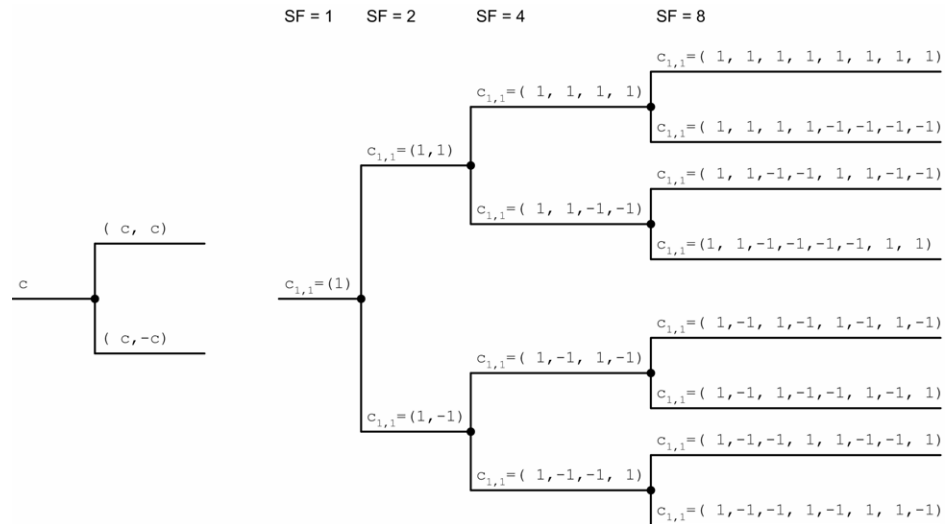

figure 3-7: Orthogonal codes tree

### 3.3.2 PSEUDO-NOISE CODES

In the downlink it is not possible to synchronize the transmission between the different cells (or between the User Equipment in the uplink), for this reason the concept of orthogonality can not be maintained.

Therefore scrambling operation is introduced.

The scrambling is done after the spreading process: The signal is further multiplied (XOR) with a pseudo-random scrambling code. These pseudorandom codes have good autocorrelation properties (measurement of the correlation between the signal and a time-delayed version of itself).

### 3.4 SYNCHRONIZATION CODES

There are two types of synchronization channels, primary and secondary, that unlike other channels, are not subjected to channelization nor scrambling. Instead they are multiplied with synchronization codes.

Primary synchronization codes (which are multiplied with the primary synchronization channel P\_SCH) are similar in all cells and are used by User Equipment during the cell-search phase.

Secondary synchronization codes (which are multiplied with the secondary synchronization channel S\_SCH) are used to identify the scrambling codes group in a cell.

### 3.5 POWER CONTROL

In WCDMA system there is a mechanism of transmitted power control: without it, a single overpowered mobile user could block a whole cell.

Power control is needed both in the uplink and in the downlink, although for different reasons

In the **uplink** direction, all signals should arrive at the base station's receiver with the same signal power. The mobile stations cannot transmit using fixed power levels, as then cells would be dominated

by users closest to the base station and distant users couldn't get their signals heard in the station. This phenomenon is called the near-far effect.

The situation is different in the **downlink** direction: there is no near-far effect. The signals transmitted by one base station are orthogonal and so they don't interfere with each other.

However, it is impossible to achieve full orthogonality in typical usage environments: signal reflections cause non-orthogonal interference even if a single base station is considered. Moreover, signals sent from other base stations are non-orthogonal and thus they increase the interference level.

We must also remember that the neighboring cells can use the same downlink frequency carrier.

Note that a mobile station close to the base station would not suffer if the signals it receives have been sent using too much power. But other users, especially those in other cells, could receive this signal as non-orthogonal noise. Therefore, power control is also needed in the downlink. The signal should be transmitted with the lowest possible power level, which maintains the required signal quality.

### 3.6 DATA MODULATION

A data modulation scheme defines how the data bits are mixed with the carrier signal, which is always a sine wave.

There are three basic ways to modulate a carrier signal in digital sense:

- Amplitude Shift Keying (ASK)
- Frequency Shift Keying (FSK)
- Phase Shift Keying (PSK)

In **ASK** the amplitude of the carrier is modified (multiplied) by the digital signal:

$$s(t) = f(t) \sin(2\pi f_c t + \phi) \quad (3.1)$$

where  $s(t)$  is the modulated carrier signal and  $f(t)$  the digital signal. ASK has the property of translating the spectrum of the modulation  $f(t)$  to the carrier frequency.

In **FSK** the frequency of the carrier signal is modified by the digital signal. If the digital signal has only two symbols, 0 or 1, this means that in the basic FSK scheme, the transmission switches between two frequencies:

$$s(t) = f_1(t) \sin(2\pi f_{c1} t + \phi) + f_2(t) \sin(2\pi f_{c2} t + \phi) \quad (3.2)$$

FSK is classified as wideband if the separation between the two carrier frequencies is larger than the bandwidth of the spectrum of  $f_1(t)$  and  $f_2(t)$ . In this case the spectrum of the modulated signal appears as two separate ASK signals.

Narrow-band FSK is the term used to describe an FSK signal whose carrier frequencies are separated by less than the width of the spectrum.

In **PSK** is the phase of the carrier signal that is modified by the digital signal:

$$s(t) = \sin[2\pi f_c t + \phi(t)] \quad (3.3)$$

There are several variants in this kind of modulation. In Binary Phase Shift Keying (BPSK) modulation, each data bit is transformed into a separate data symbol.

The mapping rule is 1 → +1 and 0 → -1. There are only two possible phase shifts in BPSK, 0 and  $\pi$  radians. It is therefore a type of ASK with  $f(t)$  taking the values 1 and -1, and its bandwidth is the same as that of ASK.

Quadrature Phase Shift Keying (QPSK) has four phases, 0,  $\pi/2$ ,  $\pi$ ,  $3\pi/2$ .

Generally, M-ary PSK has M phases,  $2\pi m/M$ ;  $m=0, 1, \dots, M-1$ .

The number of times the signal parameters (amplitude, frequency, or phase) is changed per second is called **signaling rate**. It is measured in **baud**. 1 baud = 1 change per second.

With binary modulations such as ASK, FSK e BPSK, the signaling rate equals the bit-rate. With QPSK and M-ary PSK, the bit-rate exceeds the baud rate.

The air interface of UMTS uses QPSK modulation in the downlink. The modulation chip rate is 3.84 Mcps (Mega chips per second).

## 4 UMTS SYSTEMS

The UTRA (UMTS Terrestrial Radio Access) protocol uses the WCDMA transmission technique. It means that several users share the same bandwidth at the same time. Each channel is coded and mixed with other channels. It is possible to extract the original information by multiplying once more the signal with the same code sequence.

During the communication, the emitted power is adapted with fast power control to the environment conditions (distance between terminal end cell, obstacles on the transmission channel,...). Fast power control is very important because too high power could compromise the network capacity.

UTRA supports different services (bearer) like voice, data,...(table 4-1) and can adapt the transmission rate between cell and UE: the capacity of a cell can vary in a range of 144-384 kbps in wide cells (coverage of such hundreds meters up to some thousands meter), data rate could reach up to 2 Mbps in local cells (coverage of a few tens meters). In UMTS networks the communication can be established in two different ways: circuit-switched and packet-switched. During a circuit switched transmission two users keep the connection opened from the beginning to the end of the conversation (typically for voice); in packed-switched transmission the user is always connected to the network but transmits only when necessary (typically internet access).

table 4-1: Typical bitrate in UMTS bearer

bearer	bitrate (kbps)	mode
Voice	12.2 kbps	circuit-switched
Videoconference	64 kbps	circuit-switched
...		
Data transfer	Up to 384 (2Mbps in picocells)	packet-switched

In the current configuration of UMTS network, the bearer reaches data rate up to 384 kbps but operators will differentiate users with different contracts.

The air interface UTRA supports two basics operation modes: Frequency Division Duplex (FDD) and Time Division Duplex (TDD). In the FDD mode the uplink and downlink transmission use two different carrier frequencies of 5 MHz each; whereas in the TDD mode one single 5 MHz carrier is time-shared between uplink e downlink.

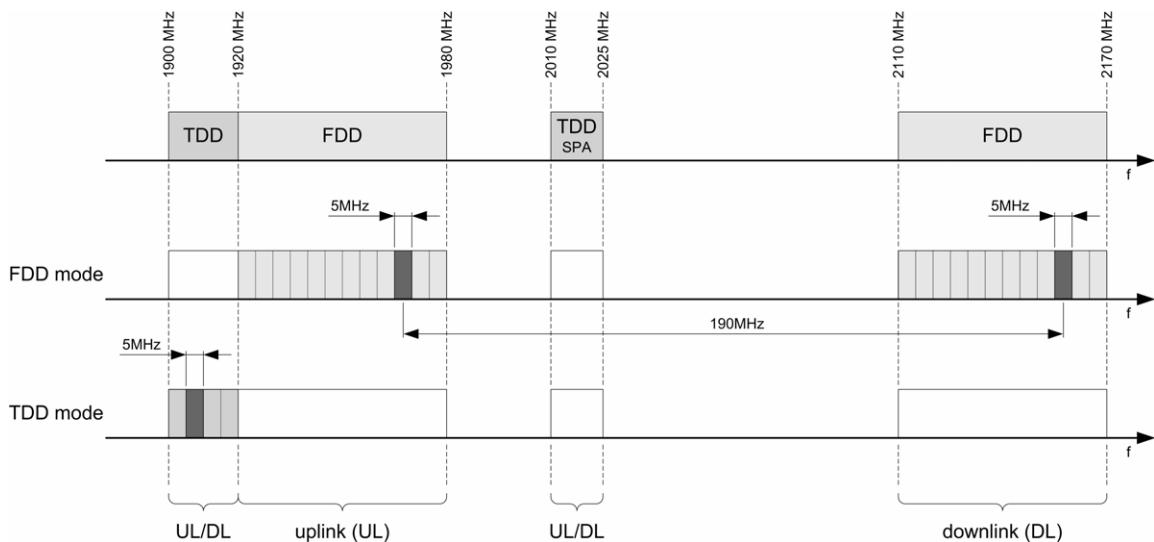

figure 4-1: TDD/FDD spectrum



## 4.1 RAN ARCHITECTURE (RADIO ACCESS NETWORK)

The architecture of UMTS systems (figure 4-2) is similar to that of GSM systems. UMTS is mainly divided in three subsystems: Core Network, Access Network and User Equipment .

Core Network (CN) is the network part that carries and switches informations and signalizations allowing the communication between different Radio Access Network sections (RAN) and other external networks (GSM,...).

The second Network RAN, called UTRAN (UMTS Terrestrial Radio Access Network), is the interface that manages relations between radio traffic and CN.

User Equipment (UE) is the interface between the radio interface and the user.

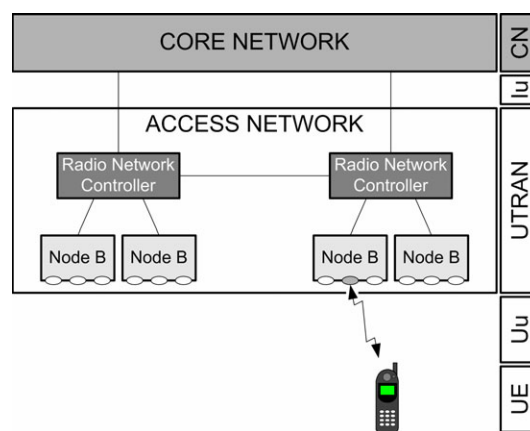

figure 4-2: Core and Access Network

UTRAN is divided in two different elements: Radio Network Controller and Node B.

The Radio Network Controller (RNC) manages radio resources of their Nodes B. The most important functions of a RNC are:

- data traffic management (common channels,...);
- admission control;
- downlink power control;
- downlink Channelization codes allocation;
- soft handover management;
- ...

The Node B can carry several cells and is most frequently called Base Station like for GSM. A Node B manages the dataflow between a radio interface and the RNC. Main functions of node B are:

- processing of RF signals;
- modulation / demodulation of physical channels;
- physical channels power regulation;
- transmission of control messages according to RNC's scheduling;
- ...

The radio interface between Node B and User Equipment has been standardized: it's the UTRA (UMTS Terrestrial Radio Access).

## 4.2 EMITTED POWER AND FAST POWER CONTROL

In UTRA power control is necessary because of the use of WCDMA technique (see dedicated chapter). It is performed 1500 times per second for both uplink and downlink. Power control is the guaranty that communication is performed with minimal transmitted power: it means that a UMTS transmitter works with mean power levels lower than GSM systems.

The emitted power of UMTS terminals is 125-250 mW (much lower than the 2 W of GSM mobiles). During normal operations the power should be kept below these maximal values. UMTS system manufacturers give emission values around 7 mW in rural areas and around 0.6 mW in urban areas.

The power emission of a cell depends on many factors: coverage, capacity, position of users in the coverage area,... . The maximal power of a cell is around 20-40 W ERP.

## 4.3 FDD AND TDD

The air interface UTRA uses two different transmission modes: **FDD** (Frequency Division Duplex) and **TDD** (Time Division Duplex).

In the FDD mode the transmission occurs on two symmetric frequency bands: one for uplink and one for downlink (figure 4-3). Each band is 5 MHz wide and is separated by 190 MHz from the corresponding duplex band: the FDD mode uses the WCDMA technique (fixed chip rate of 3.84 Mcps) with QPSK modulation for downlink and BPSK for uplink.

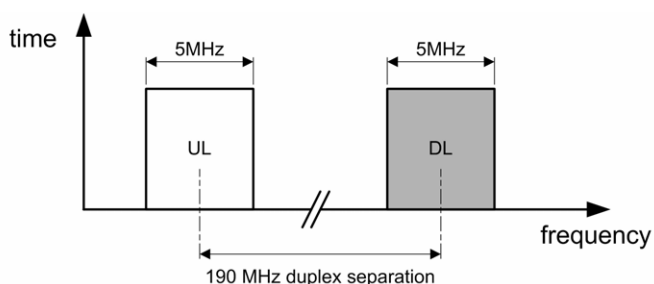

figure 4-3: FDD

In the TDD mode the transmission occurs on a single band of 5 MHz width: transmission for downlink and uplink is performed over the same band but at different times (figure 4-4). The TDD mode uses TD-CDMA technique and supports communications where there isn't symmetrical band available for FDD (i.e., for the 190 MHz separation of UL and DL). The TDD frame length is 10 ms with 15 time slots. Modulation is performed according to QPSK.

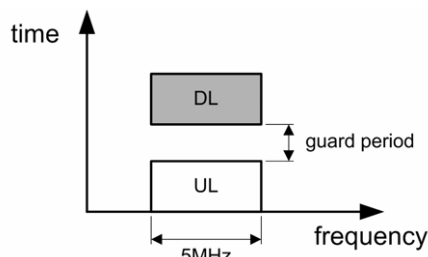

figure 4-4: TDD

TDD allows transmission of asymmetrical loads for uplink/downlink, indeed if necessary it can allocate more transmission capacity to one direction. Thus TDD is a good mode where most traffic is packet-switched like; typically internet access (most traffic in downlink direction). The TDD mode will most probably be adopted in picocells for indoor use or SPAs applications (Self Provided Applications), that is, applications that don't need special radio communication licenses because they use reserved frequencies.

#### 4.4 LOGICAL, TRANSPORT AND PHYSICAL CHANNEL

In UTRAN there are three different kinds of channels at different layers (figure 4-5): logical channels, transport channels and physical channels.

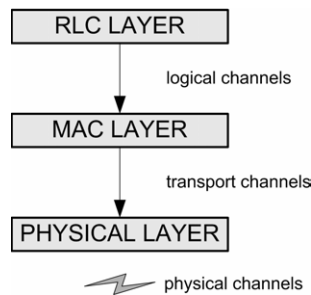

figure 4-5: UMTS channels/layers

Logical channels define which data type is transferred over the MAC layer. Logical channels are divided into two groups: common and dedicated logical channels. Common logical channels belong to point-to-multipoint communications, while dedicated logical channels belong to point-to-point communication.

Transport channels define how and with which characteristics data are transferred to the physical layer. Transport channels are the interface between the MAC layer and the physical layer.

Physical channels belong to the physical layer of the connection and their use can change because of transmission modes (FDD or TDD).

The channel mapping through different layers depends on the transmission direction (uplink/downlink) and on the TDD/FDD transmission mode. We consider only the downlink mapping of FDD and TDD modes (figure 4-6 and figure 4-7).

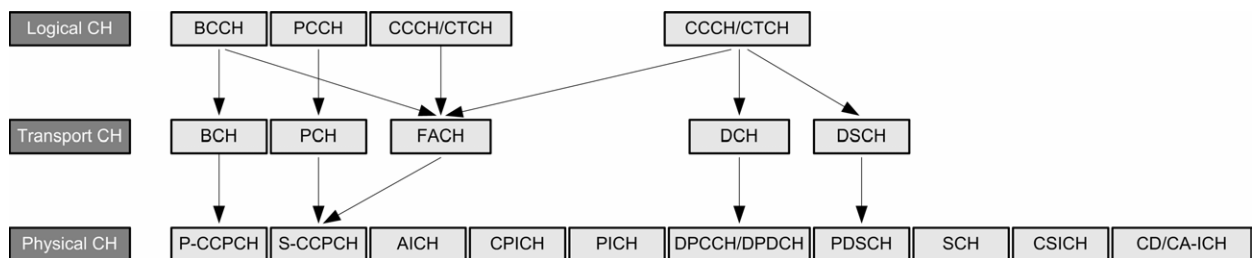

figure 4-6: Downlink channels in FDD mode

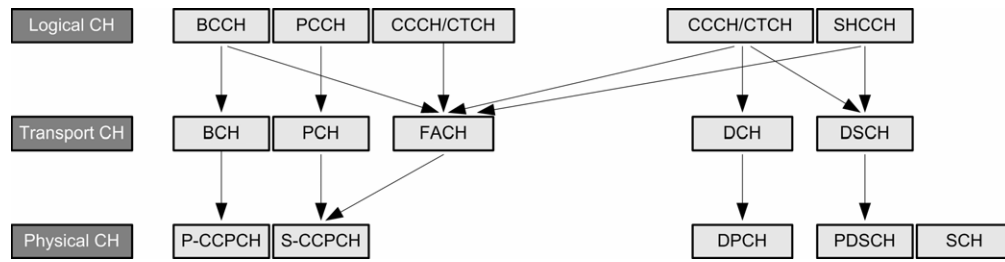

figure 4-7: Downlink channels in TDD mode

table 4-2: Channels acronyms

AICH	Acquisition Indicator Channel	FACH	Forward Access Channel
BCCH	Broadcast Control Channel	PCCH	Paging Control Channel
BCH	Broadcast Channel	P-CCPCH	Primary Common Control Physical Channel
CCCH	Common Control Channel	PCH	Paging Channel
CD/CA-ICH	Collision Detection/Assignment Indicator Channel	PDSCH	Physical Downlink Shared Channel
CPICH	Common Pilot Channel	PICH	Page Indicator Channel
CSICH	CPCH Status Indicator Channel	S-CCPCH	Secondary Common Control Physical Channel
CTCH	Common Traffic Channel	SCH	Synchronization Channel
DCH	Dedicated Channel	SHCCH	Shared Channel Control Channel
DPCCCH	Dedicated Physical Control Channel	DPDCH	Dedicated Physical Data Channel
DPCH	Dedicated Physical Channel	DSCH	Downlink Shared Channel

## 4.5 PHYSICAL CHANNELS CODING

In UMTS systems all the dedicated and common channels that belong to a cell are modulated on the same bandwidth of 5 MHz (using synchronization or spreading codes).

The cell always transmits something: common physical channels in downlink direction are always active, while dedicated channels are established only when requested by UEs.

Some downlink physical common channels are dedicated to the synchronization of the UE with cells and data is transmitted with the power necessary to reach the cell edge (maximal coverage). Dedicated traffic channels use fast power control (see WCDMA).

In general downlink physical channels are spread, scrambled with the specific cell code and transmitted with variable power (fast power control for dedicated channels) (figure 4-8).

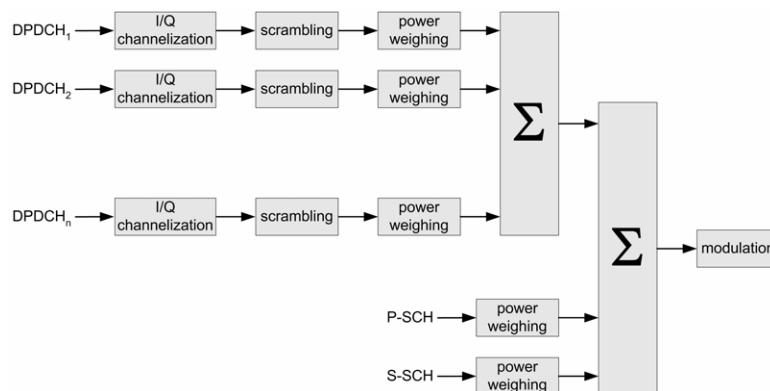

figure 4-8: Channels coding

## 4.5.1 CHANNELIZATION AND SCRAMBLING CODES FOR UTRAN

UTRAN can reuse the same channelization codes in two neighbor cells; however scrambling codes are unique for each cell (in downlink). In uplink the scrambling code of UE is unique for each user because it is not possible to obtain orthogonal channelization codes for different terminals. table 4-3 shows the properties of channelization and spreading codes used in UTRAN.

table 4-3: Channelizations/scrambling codes

		<b>channelization code</b>	<b>scrambling code</b>
use	DL	separation of data/control channels for UE	separation of UEs
	UL	separation of channels in a cell	separations of cells
length		4-256 chips (up to 512 for DL)	10ms = 38400 chips
number of codes	UL	spreading factor	some millions
	DL	spreading factor	512
type of code		OSVF	10 ms code -> Gold code
			short code -> Extended S(2)
spreading		yes, BW is spreaded	No, BW not influenced

In UTRAN the downlink spreading factor can change between 4 and 512. Since the channelization orthogonal codes are an issue of a tree structure (seen before) the number of codes is limited, thus codes have to be reused among cells. A UE could receive two coded sequences using the same channelization code that comes from different cells. The code is selected independently in every cell.

In downlink direction pseudo-random scrambling codes are used for reducing interference between cells. Each Node B has one unique primary scrambling code and UE can use it for separating signals coming from different cells. The number of pseudo-random codes is very high but only 512 codes are reserved for downlink: it should be enough for UMTS network planning.

The terminal searches for the cell's scrambling code using information received during the synchronization phase: from this operation it is possible to extract the group of codes, thus it's not necessary to try all 512 codes.

The identification of cell and code is done in three phases:

- phase 1: **slot synchronization**.  
UE uses the primary synchronization code of SCH for synchronizing on cell's slots.
- phase 2: **frame synchronization and identification of the scrambling code group**.  
UE uses the secondary synchronization code of SCH to identify the cell's scrambling code group.
- phase 3: **scrambling code identification**.  
UE defines the primary scrambling code of the cell found. The code is typically identified by symbol-by-symbol correlation on CPICH (common pilot channel) signals with all the scrambling codes of the group found in phase 2.

When the primary scrambling code has been identified, then it's possible to extract the cell information from P-CCPCH that carry BCH.

## 4.5.2 CPICH (COMMON PILOT CHANNEL)

CPICH is an unmodulated channel that is scrambled with primary scrambling code of the cell. UE estimates the CPICH's power during the connections for the cell choice. CPICH does not contain information but is a time-reference for common and dedicated channels. CPICH is a downlink physical channel for FDD mode and carries a predefined bit sequence with a fixed bitrate of 30 kbps (SF=256).

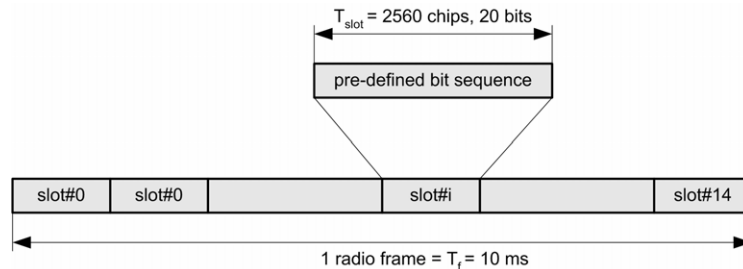

figure 4-9: Frame CPICH

There are two kinds of CPICH: primary and secondary CPICH; they differ on the usage and on the physical characteristics.

Primary CPICH (P-CPICH):

- use always the same channelization code (first orthogonal code);
- the channel is scrambled with the primary scrambling code (pseudo-random code);
- there is only one P-CPICH per cell;
- it's transmitted continuously with a power level that allows CPICH to reach the edge of the cell (maximal coverage).

Secondary CPICH (S-CPICH):

- use an arbitrary channelization code with SF=256;
- the scrambling uses primary or secondary scrambling codes;
- 0, 1 or more S-CPICH could exist per cell;
- the coverage isn't necessary along the whole cell (use power control).

P-CPICH is very important because UE needs it for the management of handovers and for the cell selection/reselection. The use of CPICH to estimate the reception level means that a regulation of CPICH can balance the load between different cells: reducing the CPICH's power some terminals will cause migration of communications to other cells; inversely increasing CPICH's power will invite more UE's on this cell.

The CPICH does not carry high level information: in fact any transport channel is mapped to it.

The power of CPICH is defined by the factor  $r$  between the power of the CPICH and the maximal power of the cell (%).

Possible values for  $r$  are in a range of 1% to 30% of the cell power: most probably 10%-15% for microcells (medium traffic), 1%-5% for picocells (high traffic).

If operators don't change the cell coverage, the power of the CPICH is stable with a typical tolerance lower than 0.5 dB.

#### 4.5.3 CCPCH (COMMON CONTROL PHYSICAL CHANNEL)

The CCPCH consists of two channels: primary (P-CCPCH) and secondary (S-CCPCH).

The primary channel P-CCPCH carries the information of the broadcast channel BCH. It has to be received and demodulated within the whole cell area. The P-CCPCH has a fixed bitrate of 30 kbps (SF 256) and does not have fast power control.

There is at least one secondary channel (S-CCPCH): it carries information of other transport channels (FACH and PCH). The bitrate is not fixed. The fast power control is not performed.

#### 4.5.4 SCH (SYNCHRONIZATION CHANNEL)

The synchronization channel is necessary during the cell search. There are two synchronization channels: primary and secondary.

The primary SCH (P-SCH) uses the same spreading sequence of 256 chips in each cell (non modulated). When several cells are on the same carrier then the P-SCH is transmitted with phase displacement between cells.

Secondary SCH (S-SCH) uses different combinations of synchronization codes. After cell synchronization, UE obtains information about the scrambling code groups (see UTRAN scrambling codes). The synchronization process is performed only one time while connecting to a new cell, otherwise terminals have enough information that avoids useless synchronization operations. Like for CPICH there isn't any transport channel mapped to SCH.

#### 4.5.5 AICH (ACQUISITION INDICATOR CHANNEL)

AICH is a channel of the physical layer. It is an echo of the uplink channel RACH (random access channel). AICH is directly controlled by the cell because it has to follow RACH very fast.

SF of this channel is 256 and as well as other channels it has to reach the edge of the cell, so no fast power control is allowed.

#### 4.5.6 PICH (PAGING INDICATOR CHANNEL)

PICH is a physical channel that carries PCH information. It manages the standby and the calls of terminals.

SF of this channel is 256 and as well as other channels it has to reach the edge of the cell so no fast power control is allowed.

#### 4.5.7 DEDICATED CHANNELS

In downlink only one kind of dedicated channel exists: the downlink DPCH (dedicated physical channel). The DPCH can be seen as a time multiplexing of DPDCH (dedicated physical data channel) and DPCCH (dedicated physical control channel). The figure 4-10 shows the frame structure of DPCH. Each slot corresponds to a period of power control. In downlink the SF is between 4 and 512.

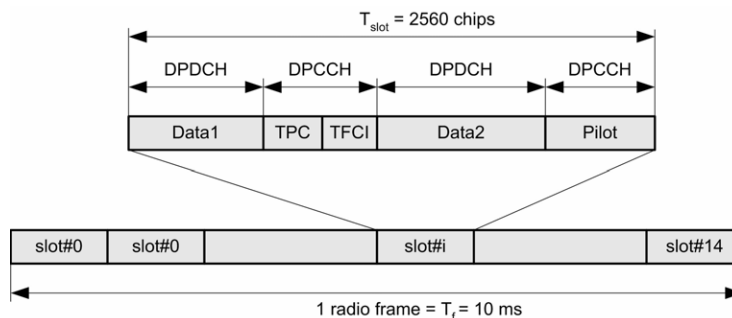

figure 4-10: frame of downlink DPCH

## 4.6 PLANNING AND MANAGEMENT OF THE UMTS NETWORK

The aim of this chapter is to explain the management issues related to UMTS networks.

### 4.6.1 CELLS STRUCTURE

The UMTS cell structure is planned in function of the environment and of the traffic density foreseen for a specific area.

Cells of different sizes can be used in different situations: on wide areas with few obstacles, bigger cells can be used; where larger transmission capacity is needed (typical situation in a city) smaller cells are required. The network can be then structured in 2 ways (figure 4-11): a classic structure with adjacent cells (a) or a hierarchical structure (b).

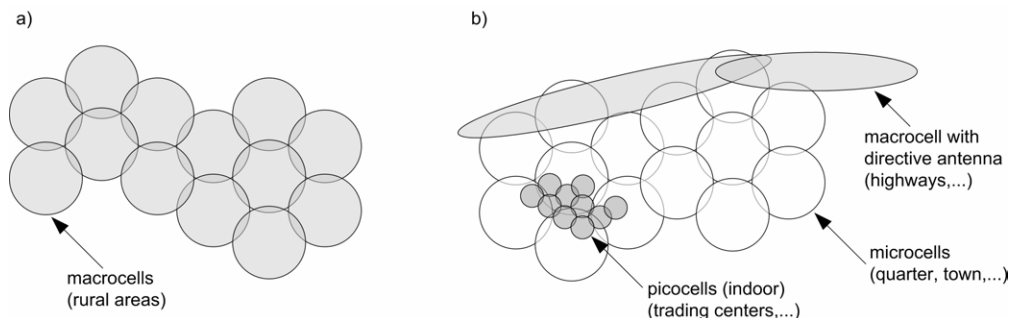

figure 4-11: UMTS cells structure

The coverage radius of the macrocells is in the order of kilometers, while for the microcells this radius can be of some hundreds of meters. Picocells are installed in very high traffic situations (offices, commercial buildings,...) . Due to the coverage radius of picocells, they cannot be installed in environments where terminals are moving at high speed (streets, highways). The problem lies in the management time required for the handover.

### 4.6.2 CELL CAPACITY AND COVERAGE

In this section, the cell behavior in some practical situations is explained.

As seen in the WCDMA technical theory, where the load influences the cell cover capacity (figure 4-12), channels which are not under power control (CPICH,...) must reach the maximum distance of the cell coverage capacity (a). If the cell is under load (b) the cell coverage area decreases. If the load due to  $UE_A$ ,  $UE_B$  and  $UE_C$  is already at the maximum level (c), the cell will not accept new users, unless the transmission speed of the already connected users is decreased, reducing in this manner the interference level.



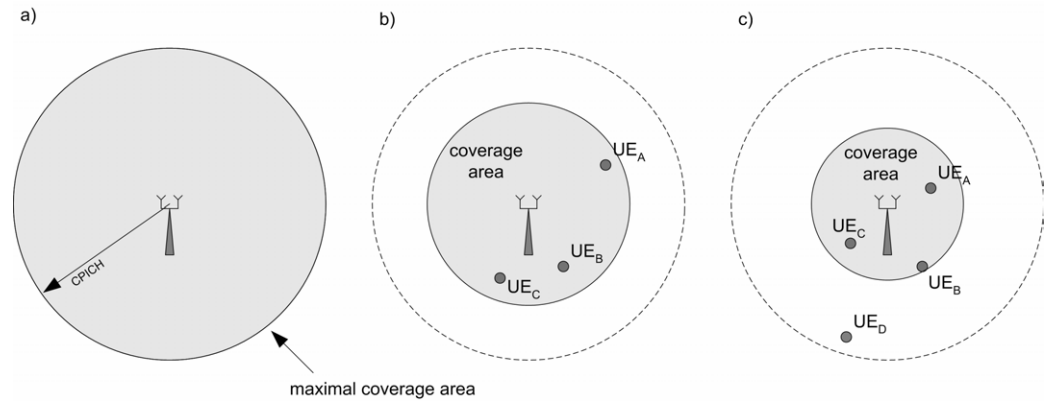

figure 4-12: Maximum cell cover capacity

The understanding of the antenna's communication behavior with respect to users is also important. Let's represent channels in the code domain (figure 4-13) and, to simplify the situation even more, let's consider the case of just one UE<sub>A</sub> user, moving away from the antenna (figure 4-14).

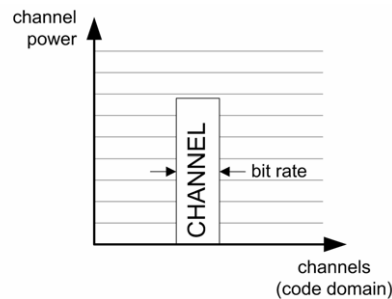

figure 4-13: Channels representation in the code domain

The scenario can be divided into five situations, where the UE<sub>A</sub> user, who is moving away from the antenna tries to obtain the maximum possible transmission speed. In all cases, the CPICH channel and the user traffic channel are always shown. The power measurements of the channels are divided into "power transmitted from the antenna" and "power received by the user". Note: variations in the rapid power control are not taken into consideration.

In the first case (a), the user is close to the Node B and receives the maximum transmission speed available of the operator (we suppose the worst case: the whole cell capacity). The transmission power is not necessarily at the maximum level.

Moving away from the cell (b), the antenna can increase the power and reach the user without modifying the bit rate. The user can move further away to the point where the transmission power is at the maximum level (c). The maximum cell power corresponds to the power dedicated to the CPICH (comprehensive of other common channels) added to the traffic channel power.

At this point (d) the antenna, in order to serve the user, must reduce the channel transmission speed (increasing SF) so that, even if the received power starts to decrease, the user will be able to despread the signal.

The speed reduction mechanism in function of the antenna's distance holds on, until the minimum speed accepted is reached (e). It is not possible to go beyond that point: in such cases the user could loose connection.

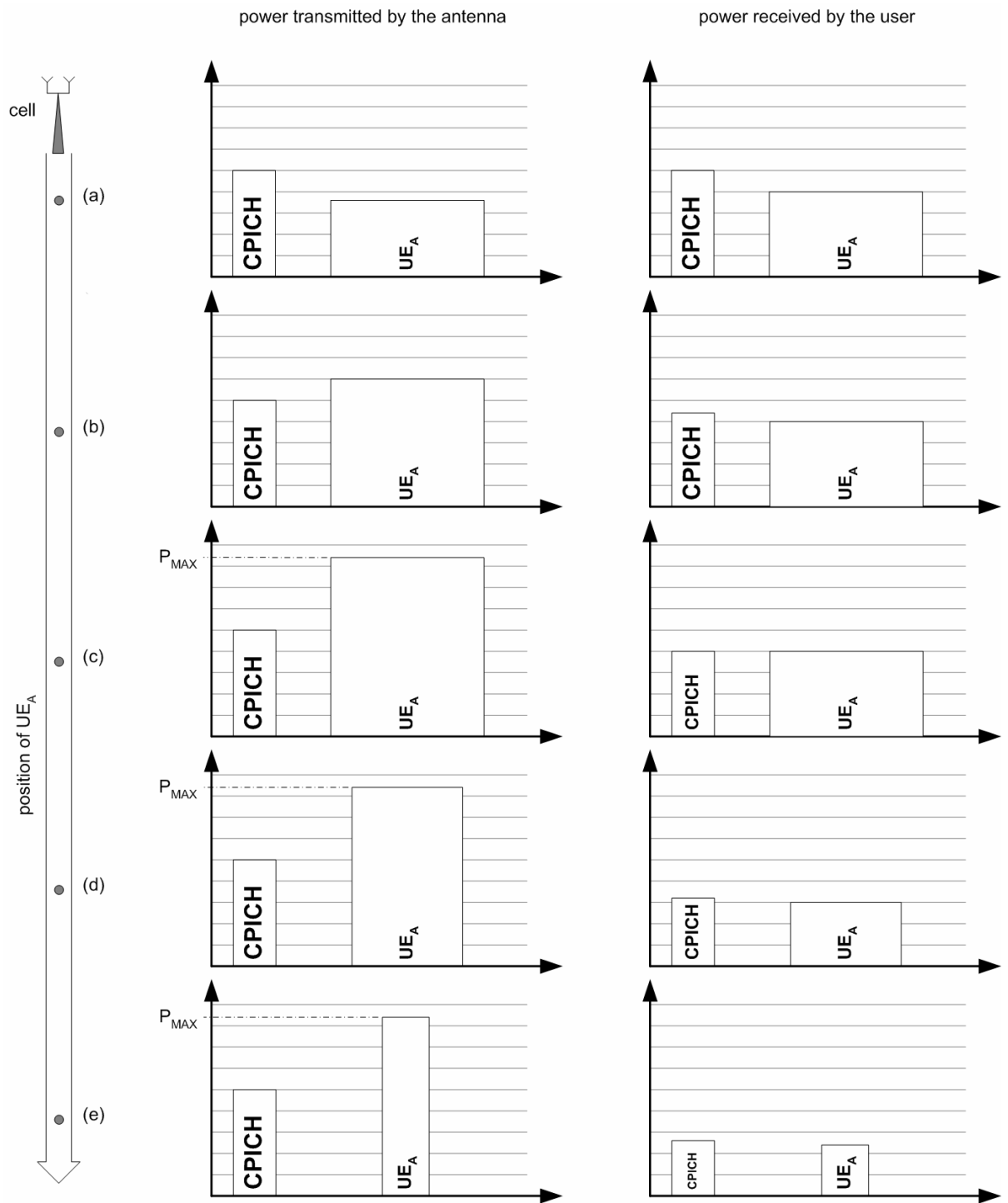

figure 4-14: Practical situations of cells use

### 4.6.3 WCDMA SYSTEM CAPACITY

As seen before, the WCDMA system capacity is given by the interference level in the network air interface. The theoretical maximum system capacity is called *pole capacity*. In a WCDMA system, where several cells interact, the maximum capacity is widely reached before the hardware resources are exhausted. In reality, the operator must consider that the system capacity must have some margin under the maximum theoretical level. There are two main reasons: it is necessary to maintain a margin on the power control and on the interference.

On terminals, the power control margin is required to give the mobile the possibility to perform fast power control (closed-loop power control).

The interference margin is required to prevent the pulsating (breathing) cell effect of the WCDMA technique, where the load affects the coverage: for example when the traffic increases it will reduce the cell coverage area radius. Because of the reduced coverage, some users connected to the cell will lose their connection, which eventually means less interference in the cell. Decreasing interference, will increase the cell size, allowing the users to establish connection again...and so on (pulsating cell).

The system capacity is under the control of RRM (Radio Resource Management) algorithms. They are applied mainly for admission control, congestion control, handover management, power control and packet scheduling.

#### **ADMISSION CONTROL**

Before admitting a new connection, admission control needs to check that the admission will not sacrifice the planned coverage area or the quality of the existing connections. Admission control accepts or rejects a request to establish a radio access from the UE. The admission control algorithm is executed each time a bearer is set up or modified. This algorithm estimates the load increase that the bearer establishment would cause on the radio network: this has to be estimated separately for uplink and downlink directions. The service can be admitted only if both admit it, otherwise it is rejected because of the excessive interference that it would produce in the network. The limits for admission control are set by the radio network planning.

In order to admit a new user, spreading codes must obviously be available and the interference must be not too high, otherwise there is a risk of an "avalanche increase": if a strong interference is created, all other users will increase their transmission power to avoid the interference; therefore the interference will increase and so on.

### **CONGESTION CONTROL**

One important task of the RRM (Radio Resource Management) functionality is to ensure that the system is not overloaded and remains stable. If the system is properly planned and the admission control and packet scheduler work sufficiently well, overload situations should be exceptional. If overload is encountered, however, the congestion control (or Load Control) returns quickly and controllably back to the targeted load.

The possible congestion control actions in order to reduce load are listed below:

- downlink fast load control: deny power increase requests from the UE;
- uplink fast load control: reduces the uplink SIR (signal to interference ratio) target used by the uplink fast power control;
- reduce the traffic of packet data in packet-switched communications;
- UE Handover to another WCDMA carrier;
- UE Handover to GSM;
- decrease bit rate of real-time users with circuit-switched conversations;
- drops low priority communications in a controlled manner.

For example, the cell could go into congestion when the user is moving away, asking the transmission power to increase. A first step to solve this problem is to decrease the data transmission bit rate. The spreading factor will increase and power will decrease, therefore interference will decrease. If not enough, the next step is to exclude a user from the cell (ex. data). Usually, voice users are privileged, but each operator has its own management algorithms.

### **HANDOVER**

There are 3 different types of handovers:

- softer handover (figure 4-15):  
UE goes from one sector to another one of the same Node B. It can be caused by the UE movement or by the congestion control;
- soft handover (figure 4-16):  
UE goes from one cell to another on a different Node B, which belongs to the same RNC.
- hard handover (figure 4-17):  
UE goes from one cell to another belonging to different RNC (CN communication network intervention).

During handover, each UE communicates with different cells at the same time: everyone demodulates the code of this UE, but just one of them is master, while other cells already see and communicate with the UE. From 1 to 6 nodes can work at the same time (nevertheless, cells use different scrambling codes).

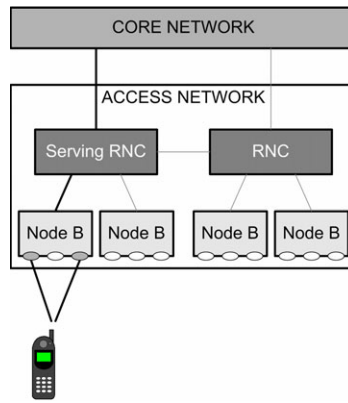

figure 4-15: Softer handover

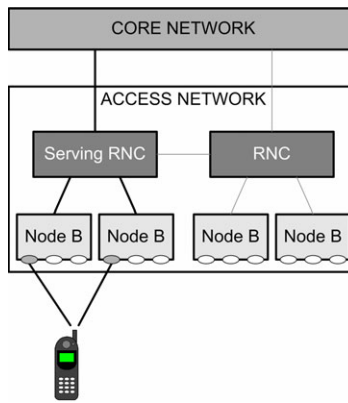

figure 4-16 Soft handover

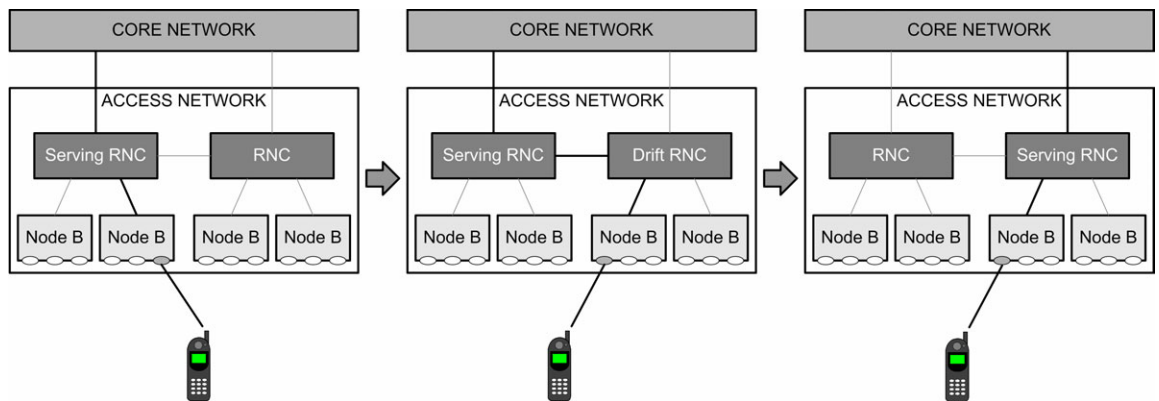

figure 4-17 Hard handover sequence

## 5 UMTS APPLICATION IN SWITZERLAND

In Switzerland, UMTS licenses were distributed among four operators:

- *Swisscom mobile SA*
- *Sunrise, TDC Switzerland SA*
- *Orange Communications SA*
- *3G Mobile SA*

### 5.1 FREQUENCY ATTRIBUTIONS

UMTS systems work on the frequency band of 2 GHz. Frequency bands available in Switzerland are shown in figure 5-1.

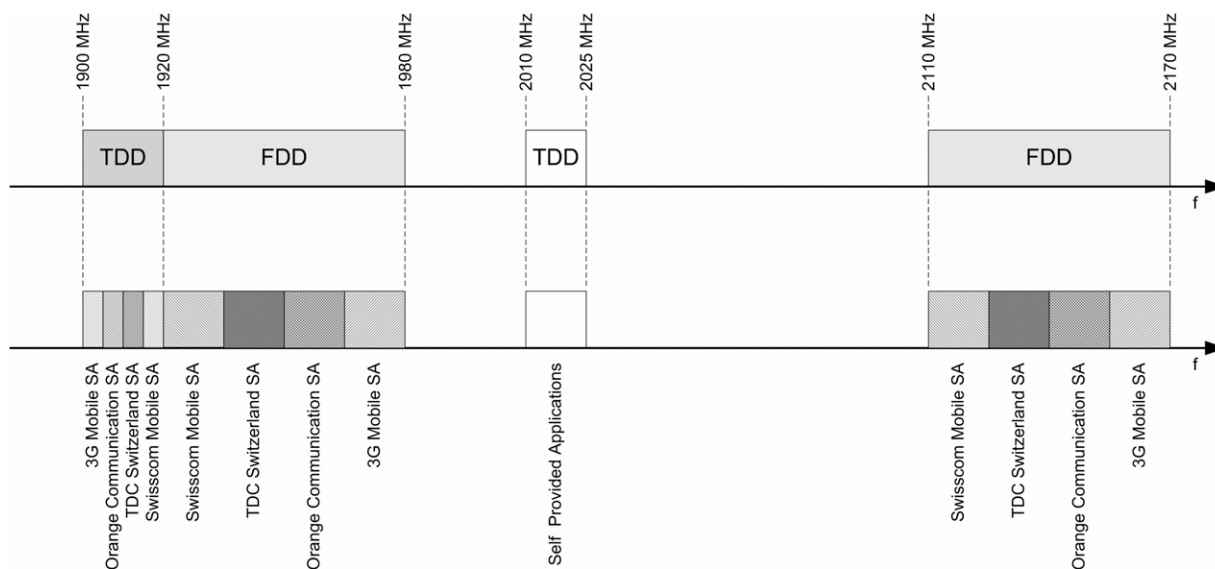

figure 5-1: Frequency bands reserved for UMTS

Grey bands are reserved for the grant owner. Also SPA frequencies are foreseen for UMTS, however, unlike the others, they are not attributed to a given operator, but can be used by everyone (without a radiocommunication grant), as it happens for wireless phone frequencies.

Each UMTS channel disposes of a 5 MHz bandwidth. In the above-mentioned bands, there are 4 channels in the partial band TDD (20 MHz) and 2 x 12 channels (2 x 60 MHz) in the partial band FDD. The channels present a bandwidth larger than GSM and each operator needs few channels for the network construction.

In Switzerland each operator disposes of 2 x 15 MHz bandwidth for FDD and 5 MHz bandwidth for TDD. Altogether each operator has 35 MHz frequency band. Frequency attributions for each operator are shown in table 5-1.

table 5-1: Frequency attribution for mobile communications operators

<b>Operator</b>	<b>FDD frequencies</b>	<b>TDD frequencies</b>
Swisscom Mobile	Uplink: 1920.5 – 1935.3 MHz Downlink: 2110.5 – 2125.3 MHz	1915.5 – 1920.5 MHz
TDC Switzerland	Uplink: 1935.3 – 1950.1 MHz Downlink: 2125.3 – 2140.1 MHz	1910.5 – 1915.5 MHz
Orange Communications SA	Uplink: 1950.1 – 1964.9 MHz Downlink: 2140.1 – 2154.9 MHz	1905.5 – 1910.5 MHz
3G Mobile	Uplink: 1964.9 – 1979.7 MHz Downlink: 2154.9 – 2169.7 MHz	1900.5 – 1905.5 MHz

## 5.2 NETWORKS

Because of the high frequencies and of the importance of the foreseen traffic, UMTS coverage will be smaller in comparison with GSM and therefore the number of base station higher. Power will be probably lower than for GSM.

table 5-2: Coverage of the cells

	<b>Antenna height</b>	<b>Cell radius</b>
Picocells	Inside buildings	100 m
Microcells	5 m from earth	500 m
Macrocells	3 m above the roof	2 km
Rural cells	30 m from the earth	8 km

During the licensing auction that took place in December 2000 the conditions were as follows:

- network coverage end 2002: 20% of the population;
- network coverage end 2004: 50% of the population;
- transmission speed: 144 kbps;
- autonomous network infrastructure;
- roaming with other networks (national roaming) admitted only if other conditions are ok.

In reality the condition fixed for end 2002 has been cancelled because at the moment there is no coverage and the availability of terminals is still scarce.

The intention of operators in 2000 was that most of the cells (more than 80%) would have been pico or microcells. Actually, the picocells idea has been abandoned and focus is on micro and macrocells located especially in the cities.

In the first phase, UMTS antennas similar to those of GSM will be installed. In the future, adaptive antennas will be used: this allows to control several antennas in order to direct the principal direction of transmission where the user is. Then the emission power and the interferences will be reduced.

UMTS network cannot reach the current coverage of GSM. Some rural places will not benefit of UMTS coverage. UMTS terminals will be equipped with GSM system as well (dual mode) in order to guarantee a satisfying coverage.

Instead of a frequency planning (obsolete because all base stations will use the same carriers), capacity and power needs to be planned for UMTS.

## 6 COMMON USE

In this chapter the possible consequences for the measurement procedure due to the common use of the installation by several mobile operators are analyzed.

In fact, the planning authority (ComCom) prefers installations that include several operators with the different technologies (GSM900, GSM800, UMTS,...).

This aspect could cause consequences on the measurement method and on its reliability. This is further discussed.

### 6.1 CONSEQUENCES ON THE MEASUREMENTS

Main consequences due to a common use of the installations by several operators can be divided in three groups:

- Consequences on a frequency level among different operators
- Consequences on a code level among the different installations of the same operator which transmits on the same frequency carrier
- Consequences on the maximum power that is easier reachable if the installation includes many transmitting cells.

Each operator disposes of several 5 MHz carriers (3 for FDD + 1 for TDD). It is easy to distinguish the different operators simply by considering the frequency band assigned to them. For this reason, on a frequency level, there are no big consequences on the measurement method with respect to GSM.

Considering a measurement method in the frequency domain with a spectrum analyzer, the frequencies would be easily separated.

Considering a measurement in the code domain it could be a problem to recognize the operator just through the scrambling code. In fact, the scrambling codes are the same for each operator, but it is possible to recognize them always through the frequency carrier.

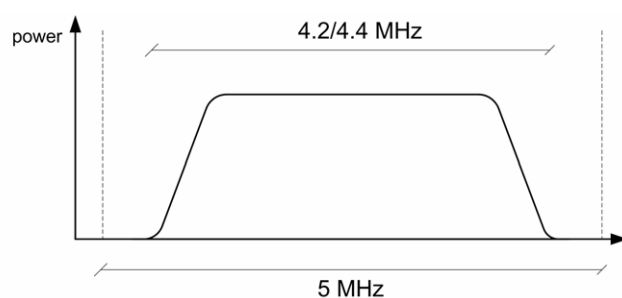

figure 6-1: UMTS signal bandwidth

Another problem to be analyzed and to examine thoroughly with measurements is that of interferences in case of adjacent carriers. The effective spectrum of a UMTS signal is concentrated and it is not really 5 MHz, but approximately 4.2-4.4 MHz. This is to avoid adjacent cell interference, in particular from other operators. The nominal distance between the different carriers is 5 MHz, but it could be modified in steps of 200 kHz depending on the adjacent cells interference limitations. Using a wider distance, the adjacent channel interference can be reduced. The distance between two carriers on the



same base station of an operator can be reduced to 4 MHz because the interference problems are completely avoided. In that case there will be more distance between the different operators (figure 6-2).

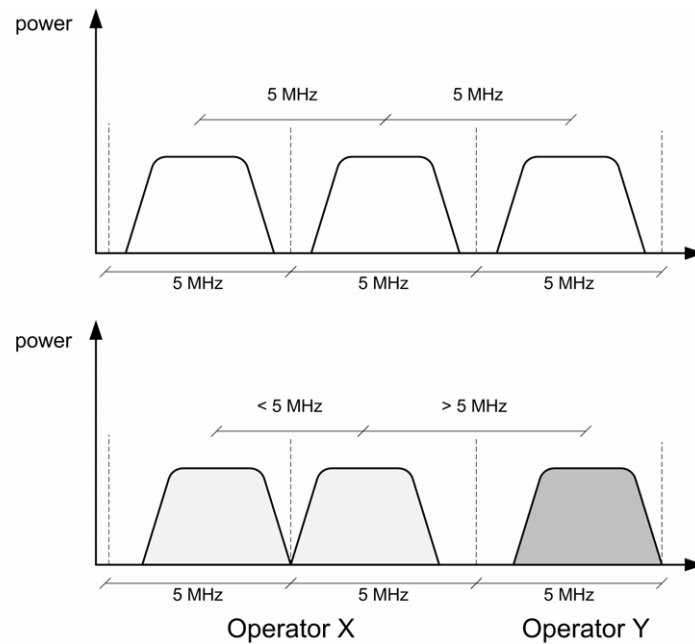

figure 6-2: Distance between different carriers

Code domain must be considered in order to distinguish between two installations of the same operator. Knowing the scrambling codes it will be easy to recognize the base station that must be measured.

When there are installations of several operators on one single pylon, possibly with several technologies (UMTS, GSM,...), it is sure that the power will assume very high values and the respective electrical field values of the installations will be higher than for GSM alone.

## **7 MEASUREMENT METHODS PROPOSAL**

### **7.1 ANALOGIES AND DIFFERENCES REGARDING GSM**

The measurement method for UMTS signals should possibly follow the principal characteristics of the method for GSM. For GSM there are two main measurement methods: a wideband method and a frequency selective method.

In GSM, the wideband method serves as an indicative measurement and a wideband probe is used. This kind of measurement doesn't allow to separate the different contributions to the electric field that come from each base station, from the mobile communication or from all others electromagnetic waves sources (radio, TV, high voltage, ...).

The Installation Limit Value is considered respected if the measured value, extrapolated to maximum authorized power is smaller or equal to the Installation Limit Value. If the limit is exceeded it doesn't automatically mean that the installation is not ok. In this case a frequency selective measurement is requested.

With a frequency selective measurement only the electrical field due to the single installation is measured.

An installation is considered ok when the measured electrical field, extrapolated to the maximum authorized power doesn't exceed the Installation Limit Value defined in NISV.

For UMTS measurements the objective is to find an indicative method that is simpler and financially less onerous, and another one which is more complete and detailed that allows to define exactly the fulfillment of the NISV limits.

Also for UMTS there will be two main measurement methods: the first in the frequency domain and the second in the code domain.

The method in the frequency domain can be used as an indicative method like the wideband method for GSM. The code domain method will allow to obtain a detailed measurement which will be the reference to evaluate if the installation respects the NISV rules or not.

## 7.2 STANDARD OPERATION

### 7.2.1 FREQUENCY DOMAIN METHOD

Unlike the GSM method, the measurement in the frequency domain cannot be considered as a selective measurement: in GSM every BCCH channel is transmitted over a different frequency carrier and thus it is easily recognized and measurable.

The UMTS signal, on the contrary, is substantially different: an UMTS carrier has a 5 MHz bandwidth which is used by all the signals of the cells of an operator. Practically the same frequency band is used by the adjacent cells and sectors. Each operator has a maximum of three 5 MHz channels. This means that it is not possible to recognize the different contribution of a cell with a frequency selective measurement. Moreover, it is not possible to recognize the amplitude of the CPICH channel.

Practically, the signal that is measured will contain several CPICH channels of several cells, all the signaling channel of the cells (SCH, CCPCH) and in addition to this all active data channels. For example, in the situation in figure 7-1 the resulting spectrum will be composed approximately as in figure 7-2.

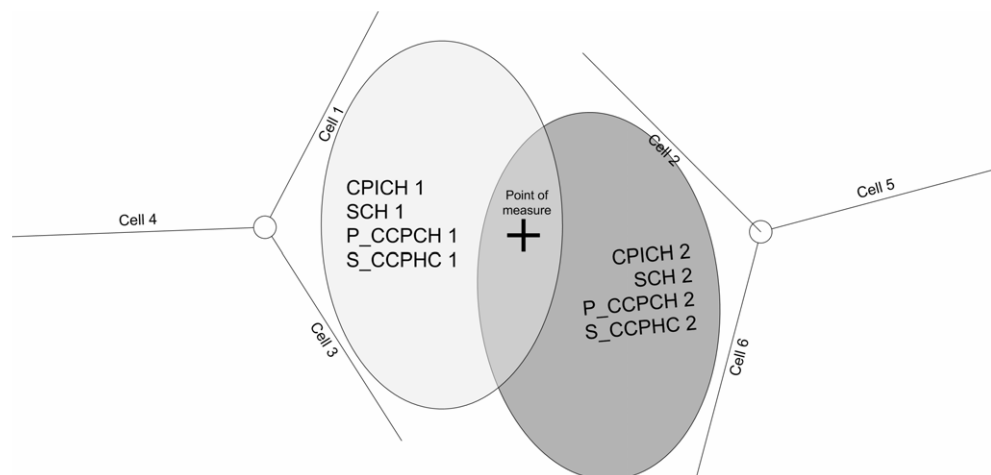

figure 7-1: Situation with two adjacent cells

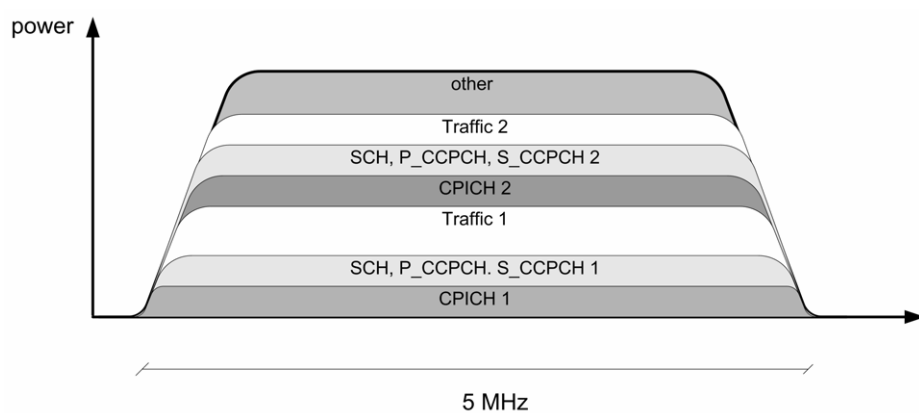

figure 7-2: WCDMA spectrum with two cells

### **MEASUREMENT OVER 5MHZ OF UMTS SIGNALS**

A UMTS signal has a 5 MHz bandwidth. Most spectrum analyzers, however, have a maximum resolution bandwidth which is smaller. Because of that, the power present in one 5 MHz frequency channel cannot be measured by reading the measured power at the carrier frequency. A correction factor  $K_1$  must be introduced in order to correct the measurement that doesn't consider the signal in his whole bandwidth. According to Mr. Martens (Gent University) this factor corresponds to the signal bandwidth divided by the noise bandwidth of the resolution filter.

Some instruments, however, allow to integrate the signal over the desired channel (5 MHz), the correction factor is no more necessary.

With this method, the financial investment (spectrum analyzer + antenna) results less than for a code domain measurement, but the result is very approximate.

### **METHODOLOGIES TO OBTAIN THE MAXIMUM VALUE OF THE ELECTRICAL FIELD**

Two main measurement methods can be considered:

- 24 hours statistics
- Conservative estimate by multiplying by a correction factor

**24 hours statistics:** the measurement should monitor the power received over a 24 hours period on days of maximum traffic in order to determine the maximum field value. This method is quite simple but it does not guarantee to find effectively the maximum value, because it is not sure that the measurement has been made in maximum traffic conditions. Moreover it needs very long periods of monitoring.

**Conservative estimate by multiplying by a correction factor:** it could give a more certain indication on the observance of the cell limits. Knowing the percentage  $r$  of power dedicated to the CPICH, the power received on the pilot channel CPICH,  $P_{CPICH}$ , is measured and it is multiplied by the inverse of the percentage  $r$  in order to obtain the maximum power  $P_{max}$  (formula 7.1).

$$P_{max} = P_{CPICH} \cdot \frac{1}{r} \quad (7.1)$$

This type of measurement approximates well the maximum electrical field if only the CPICH channel is measured. In case other channels are added to the CPICH channel (data, SCH, P\_CCPCH, S-CCPCH, ..), the maximum value of the electrical field  $E$  obtained will be approximated a lot in excess.

Pilot channels always present in UMTS are CPICH, SCH, P\_CCPCH, S\_CCPCH: if the operator could give the percentage  $x$  between the power dedicated to all these channels and the maximum power, the estimate of the maximum value of  $E$  could be considered more realistic and reliable.

It must be also considered that, especially for UMTS, cell overlapping could happen: for this reason the result obtained will be considered as the integration of all the sources present on the measured field (figure 7-2).

**ESTIMATE OF THE MEASUREMENT**

If this indicative measurement gives a result that is less than the Installation Limit Value defined in the NISV, the installation is considered alright. Otherwise, if the Installation Limit Value is exceeded, this does not mean that the installation is not ok but a selective measurement is needed (figure 7-3).

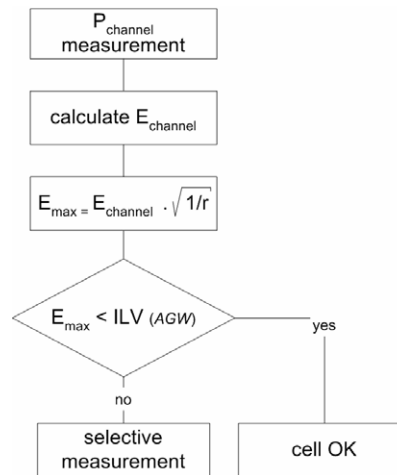

figure 7-3: Evaluation of the indicative measurement

**CURRENT ELECTRICAL FIELD VALUE CALCULATION**

Knowing the parameter  $r$  (CPICH power percentage), it is possible to calculate the current electrical field if the measurement will be on the CPICH. Obviously the result will be larger proportionally to the contribution of all other channels added to the CPICH.

The correction value could be calculated for every cell as follows:

$$Z_i = \sqrt{\frac{1}{r_i}} \quad (7.2)$$

Where:

- $Z_i$  correction factor for cell  $i$ ;
- $r_i$  power percentage of CPICH for cell  $i$ , in %.

Because it is not possible to know which CPICH is dominating in the point of measurement, the  $Z$  correction factor that will be considered is the largest of all the calculated  $Z_i$ .

The electrical field is calculated as follows:

$$E_{curr} = E_{meas} \cdot Z \quad (7.3)$$

Where:

- $E_{curr}$  maximal electrical field at the current power, in V/m;
- $E_{meas}$  measured electrical field, in V/m;
- $Z$  correction factor.

The correction factor  $K$  for the calculation at the maximum power can be calculated as in the GSM method.

## 7.2.2 SELECTIVE METHOD IN THE CODE DOMAIN

It is possible to measure the UMTS signal power in the code domain with dedicated instruments or via software. Practically, the instrument measures the power of several channels in a selective manner. Some of these instruments allow the measurement of just the pilot channel CPICH, whereas others measurement all other channels, traffic included.

Within the volume to be measured, the maximum electrical field is searched using the same method as for GSM: *Schwenkmethode*.

This method can be subdivided into two main categories depending on the instruments used:

- instruments where the scrambling code of the cell must be set by the user;
- instruments which automatically search for the scrambling code.

The purpose is always to measure the CPICH power of every cell.

**MEASUREMENT SITUATIONS**

In this chapter different measurement situations are described, from the simpler one on a single cell to the more complicated ones with several operators. The situation is schematized in figure 7-4.

Each installation is characterized by different CPICH. During the measurement, these CPICH can be set by the user or can be searched directly by the instrument. In any case, these codes have to be known in order to be associated to the different installations. Then, the power associated to each CPICH channel will be obtained,  $P_{CPICH}$ .

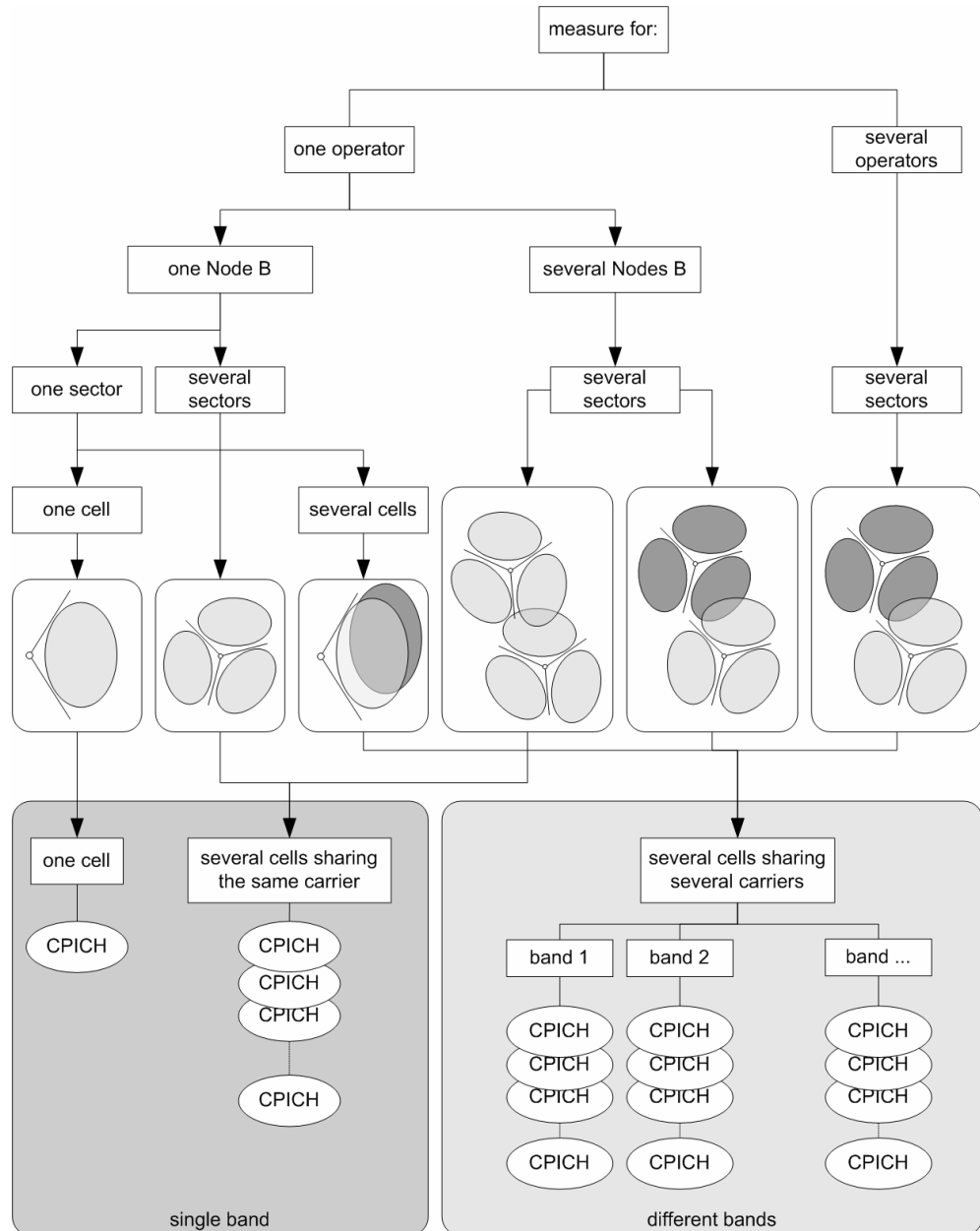

figure 7-4: Measurement situations

**CURRENT ELECTRICAL FIELD VALUE CALCULATION**

Knowing the parameter  $r$  (CPICH power percentage), it will be possible to estimate the electrical field at the current maximum power of the cell. Unlike the frequency method, in this case the exact power value of the pilot channel CPICH is known and the result will be much more precise and usable in order to evaluate the effective entity of the electromagnetic waves.

The factor for the calculation of the entire cell emissions including the traffic contribution can be calculated for each cell as follows:

$$Z_i = \sqrt{\frac{1}{r_i}} \quad (7.4)$$

Where:

- $Z_i$  Correction factor for cell  $i$ ;
- $r_i$  CPICH power percentage for cell  $i$ , in %.

This way we obtain a factor for each cell of the system.

The electrical field value is determined as follows:

$$E_{i,max} = E_{i,CPICH} \cdot Z_i \quad (7.5)$$

Where:

- $E_{i,max}$  Maximum value for current electrical field for cell  $i$ , in V/m;
- $E_{i,CPICH}$  Value of the measured electrical field of the CPICH for the cell  $i$ , in V/m;
- $Z_i$  Correction factor for the cell  $i$ .

In a second step, the correction factor  $K_i$  for the the extrapolation to the maximum authorized power according to the construction permit can be calculated like the GSM method.



### 7.2.3 CALCULATION OF E AT THE MAXIMUM AUTHORIZED POWER

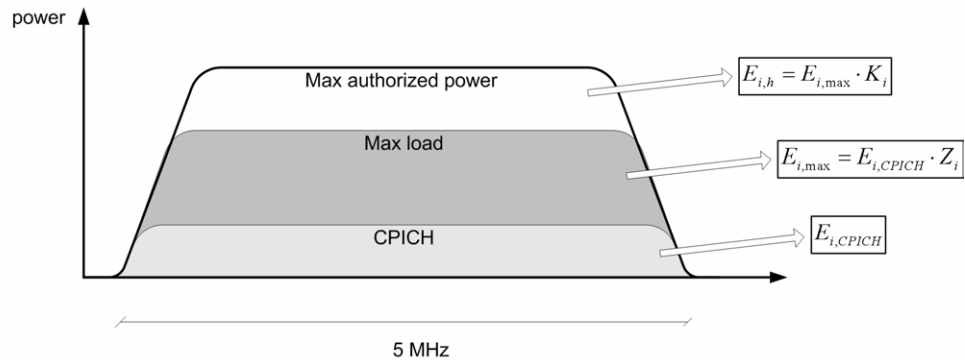

figure 7-5: Scheme for the calculation of E at the maximum authorized power

The estimate of the electrical field at the maximum authorized power is done in two steps starting from the measurement of the electrical field due to the CPICH channel (figure 7-5).

The first step consists in the calculation of the electrical field relative to the current power of the cell (Maximum load). Then, in the second step, the value of the electrical field at the maximum power authorized is calculated.

For each UMTS cell  $i$ , which is part of the installation, a factor for the estimation of the electrical field at the maximum authorized power (ERP) is calculated:

$$K_i = \sqrt{\frac{P_{i,aut}}{P_i}} \quad (7.6)$$

Where:

- $K_i$  correction factor of cell  $i$ ;
- $P_i$  current maximum power of the cell  $i$ , in W ERP;
- $P_{i,aut}$  maximum authorized power for cell  $i$ , in W ERP;

The current power of the cell must be requested directly from the operator, while the maximum authorized power can be found on the site data sheet (*Standortdatenblatt*).

This way we obtain one factor for each cell of the system.

The value of the maximum electrical field is calculated as follows:

$$E_{i,h} = E_{i,max} \cdot K_i \quad (7.7)$$

Where:

$E_{i,h}$	Electrical field at the maximum authorized power for cell $i$ , in V/m;
$E_{i,max}$	Electrical field at the maximum current power for cell $i$ , in V/m;
$K_i$	Correction factor for cell $i$ .

The reference value for the electrical field  $E_{ref}$  is calculated as follows:

$$E_{ref} = \sqrt{\sum_{i=1}^n E_{i,h}^2} \quad (7.8)$$

Where:

$E_{ref}$	electrical field of the installation at the maximum authorized power ( <i>Beurteilungswert</i> ), in V/m;
$E_{i,h}$	electrical field at the maximum authorized power for the cell $i$ , in V/m;
$n$	number of cells.

### 7.3 INSERTION OF TEST SIGNALS FOR MEASUREMENT

A special mode of operation of the installation (*Sonderbetrieb*) during measurements should be avoided, if possible. The measurement itself will lose on significance and on neutrality. Moreover, it will be a problem during the survey because it could cause a modification or an interruption of the traffic on the network.

Let's consider a scenario where a cell carries a test signal with stable power characteristics in normal operation conditions.

In the frequency domain a test signal doesn't help because in order to obtain a significant measurement it would be necessary to shut down all the other neighboring cells which are using the same carrier. The other traffic channels of the cell should fall silent as well. Otherwise the measurement result would contain contributions of other signals (as outlined in chapter 7.2.1).

A better result would be obtained by decoding the test channel, but working in the code domain isn't much different from a measurement of the CPICH that is anyway present.

According with WCDMA theory, a test signal (with an important percentage of the cell power) would generate too much interference in the air interface (see WCDMA theory). It means that other neighboring cells would be affected by the test signal coming from the tested cell: the management of this signal would be too costly for the operators.

The best thing is to perform the measurements in a standard operational state of the installation in order not to interfere with the normal operation of the network and not to create more emissions of electromagnetic fields, maybe by inserting a dedicated channel to be measured.

## 8 INSTRUMENTS EVALUATION

In this chapter, characteristics of different instrumentations/measurement systems and the effectible **measurement typology**, are described. For UMTS measurements, devices from following companies are considered: Advantest, Agilent, Anritsu, Rohde&Schwarz and Tektronix.

**Let's remark that the instrument specifications described in this report have to be considered specific to this project. For technical details on instruments, please refer to the original datasheet delivered by the manufacturer. Some characteristics may slightly differ from the manufacturer documentation.**

Measurement devices will be classified in three categories, more precisely:

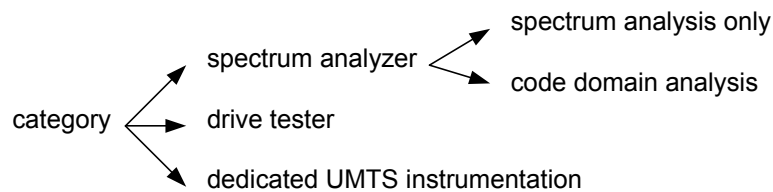

### Measurement devices by category:

<b>Spectrum Analyzer</b>	Advantest R3264/3267/3273
	Signal Analyzer R&S FSQ with WCDM-3GPP
	R&S FSP with WCDM-3GPP
	R&S FSU with WCDM-3GPP
	Tektronix YBT250
	Agilent ESA + EMSmog Clampco
	Agilent ESA-E + software for W-CDMA
<b>Drive Tester</b>	Anritsu ML8720B W-CDMA Area Tester
	Agilent E7495A, Base Station Test Set
<b>Dedicated instruments</b>	Software ROMES with Test Receiver R&S ESPI
	Agilent E6474A, wireless Network Optimization Platform

For the analysis of these devices, it is foreseen:

- a laboratory demonstration of the different devices, by connecting them to a W-CDMA source (signal generator);
- complete measurements of real UMTS installations.

**As this report is a public release, in chapters 11 and 12, instrument brands and models used for measurements and comparisons are masked.**

## 8.1 ADVANTEST

Advantest proposes just one family of instruments for UMTS signal measurements, **Spectrum Analyzers R3264/3267/3273**. They differentiate themselves just by the maximum work-frequency. For UMTS signal measurements they can be considered equivalent.

### Measurement scheme:

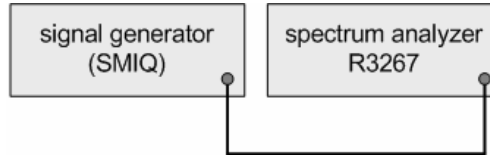

For the measurement demonstration, a Rohde&Schwarz SMIQ signal generator with the option of UMTS (W-CDMA) signals generation, has been used as UMTS source.

### Instrument:

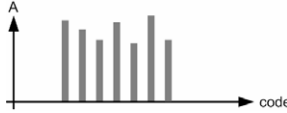

### Characteristics:

Spectrum Analyzer	<p>This device allows the direct measurement of the 5 MHz channel</p>  <p>It executes the channel despreading: measurements on the pilot channel and the traffic channels can be achieved</p>  <p>Notes:</p> <ul style="list-style-type: none"> <li>• the scrambling codes need to be set</li> <li>• measurement visualization can be in spectral lines or tabular form</li> <li>•</li> </ul>
Acquisition time	7 seconds
Other characteristics	<p>weight = 18 kg</p> <p>dimensions = 117(H) x 350(W) x 420(D)</p> <p>acquired measurements can be saved</p> <p>power supply accumulators not available</p>

## 8.2 ANRITSU

For the UMTS signal measurements, Anritsu offers just one device: **ML8720B W-CDMA Area Tester**.

**Measurement scheme:**

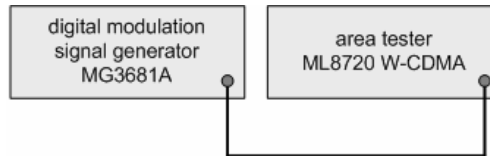

For the measurement demonstration, an Anritsu MG3681A signal generator has been used as UMTS signal source.

**Instrument:**

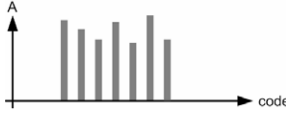

**Characteristics:**

Spectrum Analyzer	This device allows the direct measurement of the 5 MHz channel
	
	It executes the direct measurement of the pilot channel(s) (no traffic channel(s)).
	
	<p>Notes:</p> <ul style="list-style-type: none"> <li>• Max. 32 channels (scrambling code must be set for each visualized channel, ask manufacturer if necessary).</li> <li>• Measurement visualization can be in spectral lines or tabular form.</li> <li>• Signal delays (reflections on casual buildings) can be measured by channel selection.</li> <li>• Areas can be monitored by observation of the increment/decrement of the received signal level (max. 500 secs, max speed 100 km/h)</li> </ul>
Acquisition time	< 1 second (depending on the number of visualized channels)
Other characteristics	weight = 4 kg dimensions (mm) = 194(H) x 290(W) x 78(D) acquired measures can be saved power supply accumulators available (3h) GPS interface field instrument

## 8.3 ROHDE&SCHWARZ

Rohde&Schwarz proposes four measurement devices and a device specific software for UMTS signals. For the demonstration, only two instruments have been considered. Each instrument will be analyzed here in different sections. Nevertheless, for UMTS signal measurements Rohde&Schwarz offers a separated option that can be added in the device (just for three of them).

### 8.3.1 SOFTWARE ROMES WITH TEST RECEIVER R&S ESPI

Note: the ROMES Software Option is a UMTS PN Scanner. This software allows the signal "despreading" for the acquisition of the respective pilot channels.

For this test, the Test Receiver R&S ESPI has been used. Nevertheless, the software compatibility with the other 3 instruments is granted.

Measurement scheme:

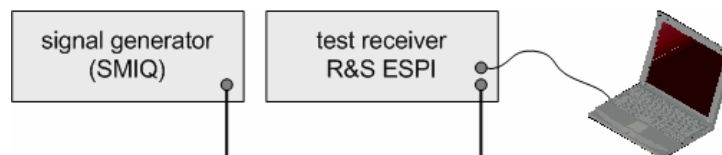

For the demonstration, a Rohde&Schwarz SMIQ signal generator with optional UMTS signal generation, has been used.

**Instrument:**

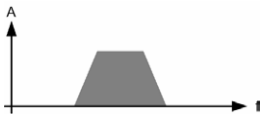
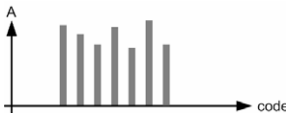

**Characteristics:**

Spectrum Analyzer	<p>This device allows the direct measurement of the 5 MHz channel</p>  <p>It executes the channel "despreading". Measurements on the pilot channel(s) are possible (pilot channel(s) only).</p>  <p>Notes:</p> <ul style="list-style-type: none"> <li>• scrambling code not needed. Software synchronizes itself and delivers code to the operator</li> <li>• measurement visualization can be in spectral lines or tabular form.</li> </ul>
Acquisition time	0.3 second
Other characteristics	<p>weight = 10.5 kg</p> <p>dimensions (mm) = 197(H) x 412(W) x 417(D)</p> <p>acquired measures can be saved</p> <p>power supply accumulators available</p> <p>need of a PC or laptop</p>

Note: the Test Receiver R&S ESPI doesn't have the option WCDMA-3GPP.

### 8.3.2 SIGNAL ANALYZER R&S FSQ WITH WCDMA-3GPP OPTION

**Measurement scheme:**

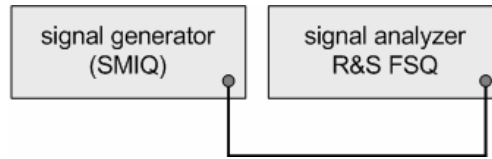

For the demonstration, a Rohde&Schwarz SMIQ signal generator with the UMTS signal generation option has been used as UMTS signal source.

**Instrument:**

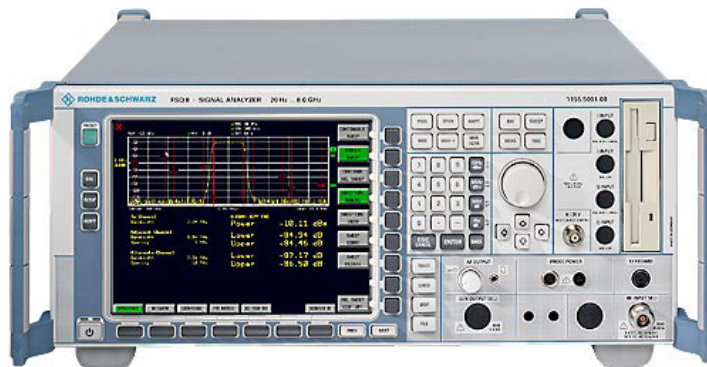

**Characteristics:**

Spectrum Analyzer	This device allows the direct measurement of the 5 MHz channel
	It executes the channel "despreading": pilot channel and traffic channel(s) measurements are possible.
	Notes: <ul style="list-style-type: none"> <li>• requires to set the <b>scrambling codes</b></li> <li>• measurement visualization can be in spectral lines or tabular form</li> </ul>
Acquisition time	1 second
Other characteristics	weight = 14.6 kg
	dimensions (mm) = 192(H) x 435(W) x 460(D)
	acquired measurements can be saved
	no power supply accumulators available



### 8.3.3 SPECTRUM ANALYZER R&S FSP WITH WCDMA-3GPP OPTION

**Instrument:**



**Characteristics:**

Spectrum Analyzer	This device allows the direct measurement of the 5 MHz channel
-------------------	--



It executes the channel "despreading": measurements on the pilot channel and traffic channel(s) are possible.

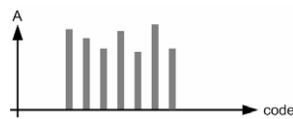

Notes:

- it requires setting of the **scrambling codes**
- measurement visualization can be in spectral lines or tabular form

Acquisition time	5 seconds
Other characteristics	weight = 10.5 kg
	dimensions (mm) = 197(H) x 412(W) x 417(D)
	acquired measurements can be saved
	power supply accumulators available

### 8.3.4 SPECTRUM ANALYZER R&S FSU WITH WCDMA-3GPP OPTION

No practical demonstration has been done on this device.

**Instrument:**

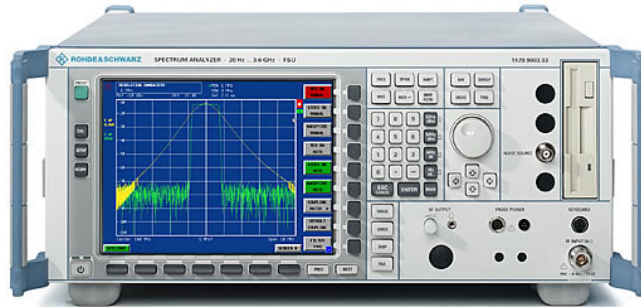

**Characteristics:**

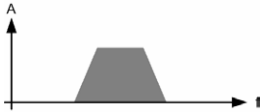
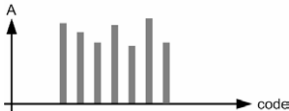
Spectrum Analyzer	<p>This device allows the direct measurement of the 5 MHz channel</p>  <p>It executes the channel "despreading": measurements on the pilot channel and traffic channel(s) are possible.</p>  <p>Notes:</p> <ul style="list-style-type: none"> <li>• it requires setting of the <b>scrambling codes</b></li> <li>• measurement visualization can be in spectral lines or tabular form</li> </ul>
Acquisition time	4 seconds
Other characteristics	weight = 14.6 kg dimensions (mm) = 192(H) x 435(W) x 460(D) acquired measurements can be saved power supply accumulators not available

## 8.4 TEKTRONIX

Tektronix offers one instrument for the UMTS signal measurement: **YBT250**.

### Instrument:



### Characteristics:

Spectrum Analyzer	This device allows the direct measurement of the 5 MHz channel
	It executes channel "despreading": measurements on the pilot channel and traffic channel(s) are possible.
	<p>Notes:</p> <ul style="list-style-type: none"> <li>• no need to know the scrambling code for the measurement of the channel with highest power (device synchronizes itself automatically). For channels with less power the scrambling code is needed.</li> <li>• only one channel measurement is allowed</li> <li>• results can be saved in tabular form. On the display only the graphical representation is available</li> </ul>
Acquisition time	1 second. For very low power signals, the device requires more processing time, caused by a possible loss of synchronism
Other characteristics	weight = 4.1 kg
	dimensions (mm) = 249(H) x 330(W) x 89(D)
	acquired measurements can be saved
	power supply accumulators available
	field instrument

## 8.5 AGILENT

Agilent offers 4 instruments for UMTS signal measurements. They will be analyzed in different sections.

### 8.5.1 AGILENT E7495A, BASE STATION TEST SET

For this instrument we could follow a demonstration. Nevertheless, the UMTS signals analysis module will be available in September 2003. Device characteristics are still vague.

**Instrument:**

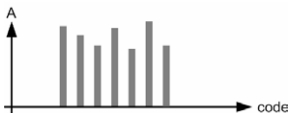

**Characteristics:**

Spectrum Analyzer	This device allows the direct measurement of the 5 MHz channel
	
	It executes the channel "despreading": measurements of the pilot channel and of the traffic channel(s) are possible.
	
	<p>Notes:</p> <ul style="list-style-type: none"> <li>• scrambling codes are needed</li> <li>• measurement visualization can be in spectral lines or tabular form</li> <li>• internal GPS</li> </ul>
Acquisition time	N/A
Other characteristics	weight = 9.1 kg dimensions (mm) = 295(H) x 368(W) x 135(D) measurements can be saved power supply accumulators available field instrument

### 8.5.2 AGILENT SPECTRUM ANALYZER ESA SERIE + EMSMOG CLAMPCO SYSTEM

No practical demonstration available.

The Clampco module has been developed for the Agilent ESA Series Spectrum Analyzers. Compatibility with other models (even older) should be granted.

The Clampco device for UMTS measurements has a receiver (that has to be connected to a PC) and a probe. The Spectrum Analyzer is required for the spectral window selection.

**Connection scheme:**

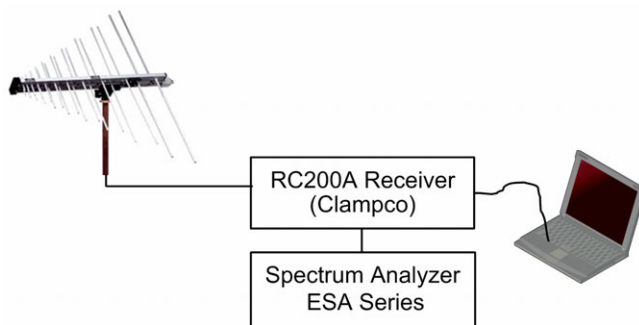

**Instrument:**



**Characteristics:**

Spectrum Analyzer	this device allows the direct measurement of the 5 MHz channel
	no decoded signal measurement
Acquisition time	N/A
Other characteristics	the probe allows the automatic measurement on the three axes (motorized antenna). Probe must be obviously fixed to a support measurements can be saved power supply accumulators available need of a PC and of a receiver

### 8.5.3 AGILENT ESA-E SERIES SPECTRUM ANALYZERS E4402B + SOFTWARE FOR W-CDMA

Agilent is offering an entire family of devices for UMTS signal measurements: Spectrum analyzers **series ESA-E4401B -E4402B -E4404B -E4405B -E4407B**. They differ only from the maximum working frequency; for UMTS signal measurements they must be considered equivalent.

A module must be added to receive W-CDMA signals.

For the practical demonstration we used the Spectrum Analyzer E4402B.

#### Measurement scheme:

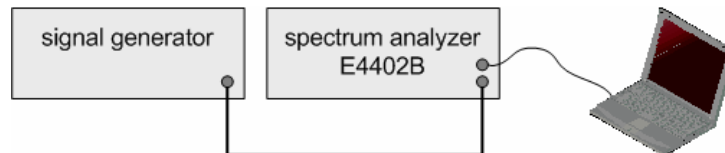

For the measurement demonstration, an Agilent source generator with UMTS signal generation option has been used.

#### Instrument:

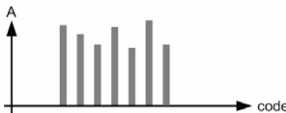

## Characteristics:

Spectrum Analyzer	<p>this device allows the direct measurement of the 5 MHz channel</p>  <p>it executes the channel "despreading": measurements of the pilot channel and of the traffic channel(s) are possible</p>  <p>Notes:</p> <ul style="list-style-type: none"> <li>• scrambling codes are needed</li> <li>• measurement visualization can be in spectral lines or tabular form</li> </ul>
Acquisition time	20 seconds.
Other characteristics	<p>weight = 15.5 kg</p> <p>dimensions (mm) = 222(H) x 373(W) x 409(D)</p> <p>measurements can be saved</p> <p>power supply accumulators available</p> <p>12V power supply available</p> <p>field instrument</p> <p>need of a PC or a laptop</p>

### Note:

Agilent is offering the direct despreading software integration for the **PSA series** only. These devices are for indoor use only, because they are very sensitive to atmospheric changes.

### 8.5.4 AGILENT E6474A, WIRELESS NETWORK OPTIMIZATION PLATFORM

No practical demonstration available.

The measurement system is based upon the connection of a PC with installed Agilent software and a UMTS terminal. With the PC all information from the NodeB to the UMTS terminal can be visualized. It is also possible to use a specific UMTS receiver.

**Instrument:**



**Characteristics:**

Spectrum Analyzer	<p>this instrument doesn't allow the direct channel measurement</p> <p>it executes the channel "despreading": measurements of the pilot channel and of the traffic channel(s) are possible.</p> <div style="text-align: center;"> </div> <p>Notes:</p> <ul style="list-style-type: none"> <li>• scrambling code settings are needed or, by using a UMTS terminal, they will be directly set by the operator.</li> <li>• measurement visualization can be in spectral lines or tabular form.</li> <li>• no power measurements</li> </ul>
Acquisition time	N/A
Other characteristics	<p>measurements can be saved</p> <p>power supply accumulators available</p> <p>field instrument, laptop + mobile phone</p>

### 8.6 MEASUREMENT DEVICES EVALUATION

The evaluation and proposal of the most appropriate measurement devices in the frequency and code domain will be done in the second part of the mandate. It will be based upon :

- laboratory test;
- on-site tests with real UMTS installations.



## 8.7 INSTRUMENTS COMPARATIVE TABLE - GENERAL OVERVIEW

	Spectral measurement	Pilot channel measurement	Traffic channel measurement	No scrambling code knowledge	Water proof and shock resistant	Measurements storage	Power supply accumulators	Optimal for weight and dimension (field instrument)	RMS detection
<b>Advantest</b> Spectrum Analyzers R3264/3267	ok	ok	ok	no	no	ok	no	no	ok
<b>Anritsu</b> ML8720B W-CDMA Area Tester	ok	ok	no	ok (?)	ok	ok	ok	ok	??
<b>Rohde&amp;Schwarz</b> Software ROMES3 + Test Receiver R&S ESPI	ok	ok	no	ok	no	ok	ok	no	ok
<b>Rohde&amp;Schwarz</b> Signal Analyzer R&S FSQ with WCDMA-3GPP	ok	ok	ok	no	no	ok	no	no	ok
<b>Rohde&amp;Schwarz</b> Spectrum Analyzer R&S FSP with WCDMA-3GPP	ok	ok	ok	no	no	ok	ok	no	ok
<b>Rohde&amp;Schwarz</b> Spectrum Analyzer R&S FSU with WCDMA-3GPP	ok	ok	ok	no	no	ok	no	no	ok
<b>Tektronix</b> YBT250	ok	ok	ok	ok/no	ok	ok	ok	ok	???
<b>Agilent</b> E7495A, Base Station Test Set	ok	ok	ok	no	ok	ok	ok	ok	ok
<b>Agilent</b> Spectrum series ESA + EMSmog Clampco	ok	no	no	no	ok/no	ok	ok	no	ok
<b>Agilent</b> ESA-E series Spectrum Analyzer + software for W-CDMA	ok	ok	ok	no	ok	ok	ok	ok/no	ok
<b>Agilent E6474A</b> Wireless Network Optimization platform	no	ok	ok	ok/no	no	ok	ok	ok/no	no

## 8.8 INSTRUMENTS COMPARATIVE TABLE - TECHNICAL SPECIFICATIONS

	Input frequency range	Maximum input level	Operating temperature	Storage temperature	Resolution bandwidth range	Time to execute one measurement	Minimum input level to execute one measurement	Power consumption
<b>Advantest</b> Spectrum Analyzers R3264/3267	9kHz to min 3.5 GHz	+ 30 dBm	0 to 50°	-20° to 60°	1Hz to 10 MHz	4-5 sec.	- 50 dBm	300 W
<b>Anritsu</b> ML8720B W-CDMA Area Tester	2110 MHz to 2200 MHz	- 30 dBm	0° to 40°	-25° to 60°	4 kHz	0.6 sec x the number of channel	-117 dBm ??	30 W
<b>Rohde&amp;Schwarz</b> Software ROMES + Test Receiver R&S ESPI	20Hz to min 3 GHz	137 dBuV	Specified 5° to 40° Functional 5° to 45°	-40° to 70°	10 Hz to 10 MHz	0.3 sec.	???	120 W
<b>Rohde&amp;Schwarz</b> Signal Analyzer R&S FSQ with WCDMA-3GPP	20Hz to min 3.6 GHz	+ 30 dBm	Specified 5° to 40° Functional 0° to 50°	-40° to 70°	10 Hz to 20 MHz	1.5 sec.	-70 dBm	150 W
<b>Rohde&amp;Schwarz</b> Spectrum Analyzer R&S FSP with WCDMA-3GPP	20Hz to min 3 GHz	+ 30 dBm	0° to 50°	-40° to 70	10 Hz to 10 MHz	5 sec.	- 70 dBm	300 W
<b>Rohde&amp;Schwarz</b> Spectrum Analyzer R&S FSU with WCDMA-3GPP	20Hz to min 3.6 GHz	+ 30 dBm	Specified 5° to 40 Functional 0° to 50°	-40° to 70°	10 Hz to 20 MHz	4 sec.	- 70 dBm	310 W
<b>Tektronix</b> YBT250	30 MHz to 2500 MHz	+ 30 dBm	Specified 0° to 50° Functional -10° to 50°	-40° to 60°	100 Hz to 6 MHz	1 sec	- 78 dBm	< 60 W
<b>Agilent</b> E7495A, Base Station Test Set	10 MHz to 2500 MHz	+ 20 dBm	-10° to 50°	-40° to 70°	???	???	???	50 W
<b>Agilent</b> Spectrum series ESA (E4402B) + EMSmog Clampco	9 kHz to 3 GHz	+ 50 dBm (with 30 dB attenuator)	0° to 50°	-40 to 55°	1 kHz to 5 MHz	Sweep Spectrum Analyzer	???	< 300 W
<b>Agilent</b> ESA-E series Spectrum Analyzer + software for W-CDMA	9 kHz to 3 GHz	+ 50 dBm (with 30 dB attenuator)	0° to 50°	0° to 50°	1 kHz to 5 MHz	20 sec	- 70 dBm	< 300 W
<b>Agilent E6474A</b> Wireless Network Optimization platform	UMTS range	+ 10 dBm	0° to 50°	-40° to 70°	---	???	- 65 dBm???	10 W

	Amplitude accuracy	Frequency span accuracy	Level resolution					
<b>Advantest</b> Spectrum Analyzers R3264/3267	± 1.5 dBm	1 %	0.1 dB					
<b>Anritsu</b> ML8720B W-CDMA Area Tester	± 2 dBm	---	0.1 dB					
<b>Rohde&amp;Schwarz</b> Software ROMES +Test Receiver R&S ESPI	< ±1.5 dB	1 %	0.01 dB					
<b>Rohde&amp;Schwarz</b> Signal Analyzer R&S FSQ with WCDMA-3GPP	< ±0.5dB	1 %	0.1 dB					
<b>Rohde&amp;Schwarz</b> Spectrum Analyzer R&S FSP with WCDMA-3GPP	< ±0.2 dB	0.1 %	0.1 dB					
<b>Rohde&amp;Schwarz</b> Spectrum Analyzer R&S FSU with WCDMA-3GPP	< ±0.2 dB	0.1 %	0.1 dB					
<b>Tektronix</b> YBT250	± 1 dBm	???	1 dB					
<b>Agilent</b> E7495A, Base Station Test Set	± 1.5 dBm	???	???					
<b>Agilent</b> Spectrum serie ESA (E4402B) + EMSmog Clampco	± 1 dB	0.5 %	0.1 dB					
<b>Agilent</b> ESA-E series Spectrum Analyzer + software for W- CDMA	± 1 dB	0.5 %	0.1 dB					
<b>Agilent E6474A</b> Wireless Network Optimization platform								



## **9 INTERNATIONAL RESEARCH**

The goal of this research was to identify researchers active in the field of UMTS signal measurements. The contacts established during the research are indicated in this section. For every contact it is possible to find the profile of the company, contact persons, condition of the contact and possible future collaborations.

Contacts that came out of the research will be useful to the prosecution of our project. Moreover we have gathered a lot of documentation that has been catalogued: different publications and reports that have a direct connection with the technology UMTS or GSM (with reference to UMTS).

### **9.1 CONTACTS**

Left intentionally blank for privacy protection.

## 10 MEASUREMENT OF UMTS SIGNALS

Three main types of measurement were used during the laboratory and on-site measurement campaigns described in chapters 11 and 12:

- spectral measurement with RBW 1MHz and RBW 5MHz;
- measurement of UMTS channel power;
- code domain measurement of CPICH channel.

Spectral power measurements were performed using the basic functions for power measurements of the spectrum analyzers. Measurements were performed with different input resolution bandwidths: 1 MHz RBW, which is a common filter width for most spectrum analyzers and 5 MHz RBW, which is not always provided on older instruments.

Most modern instruments allow the measurement of the RF channel power, that is, a frequency domain measurement of the power within a given spectral bandwidth (channel), calculated by software routines. In the next chapters it is referred to as *UMTS channel power* ( $P_{\text{channel}}$ ).

Code domain measurements are applied when it is necessary to resolve each physical channel present on a UMTS carrier of 5 MHz bandwidth.

At the end of this chapter an overview of the measurements taken with different instruments is given to show how the measurement results are displayed.

### 10.1 SPECTRAL MEASUREMENT

The spectral measurement is a simple power measurement performed with a spectrum analyzer in the frequency domain.

Measurements were performed with different input RBW filters; in fact, especially for wideband signals, the measured power depends on the RBW filter set on the instrument. Since a UMTS signal has a 5 MHz bandwidth, a RBW of 5 MHz should be set at the spectrum analyzer in order to correctly measure the power present on a UMTS carrier. Wider RBW should be avoided to enable the distinction between two adjacent channels.

Actually, older spectrum analyzers, have a maximum RBW smaller than 5 MHz (typically 1 MHz). In this case the measured power at the carrier frequency is lower than the total power within the 5 MHz UMTS channel. The next two figures show the max\_hold envelope of a UMTS signal measured with a RBW filter of 1 MHz (figure 10-1) and 5 MHz (figure 10-2). The instrument was set to peak-detector mode.

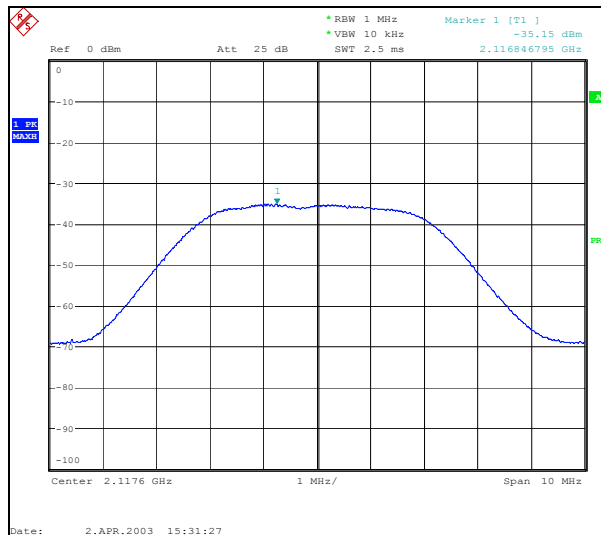

figure 10-1: Spectral measurement of a UMTS signal with RBW=1 MHz

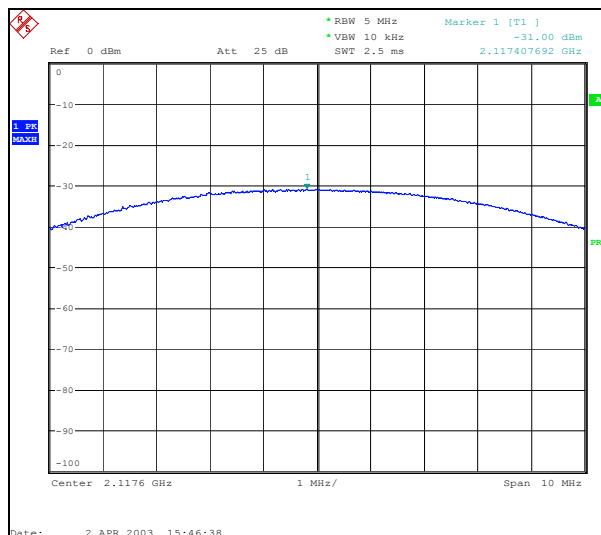

figure 10-2: Spectral measurement of a UMTS signal with RBW=5 MHz

When a measurement is performed using RBW filters smaller than 5 MHz, a correction factor  $K_1$  must be applied in order to estimate the power of the whole UMTS channel. Theoretically, this factor is equal to the signal bandwidth divided by the noise bandwidth of the resolution filter [L. Martens].

If Gaussian RBW filters are used, it is possible that part of the adjacent channels power is included in the measured value (figure 10-3). This would not happen using rectangular filters, therefore, most modern instruments are provided with a function called *UMTS channel power* measurements (see chapter 10.2).

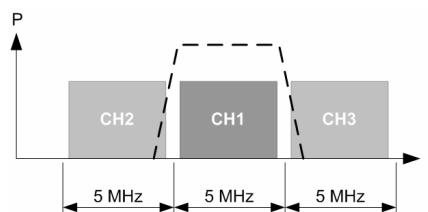

figure 10-3: Spectral measurement of 3 adjacent UMTS signals with RBW filter 5 MHz

## 10.2 UMTS CHANNEL POWER MEASUREMENT

Most modern instruments allow the measurement of the RF channel power, that is, they perform in the frequency domain an integration of the power within a given bandwidth, the integration being calculated by software routines: it is a dedicated measurement that takes into consideration the signal characteristics. In the next chapters it is referred to as *UMTS channel power* ( $P_{channel}$ ).

The measurement on the UMTS channel (3.84 MHz) is performed with a RMS detector using a RBW much narrower than the signal bandwidth (typically 30 kHz). In addition to this, the signal is filtered with a rectangular filter in order to avoid sampling of adjacent channels. Afterwards an integration on the whole channel bandwidth is done.

As an alternative to the integration with rectangular filters, a Gaussian filter could also be used and the measured trace would have to be numerically corrected point by point with a root raised cosine function. At the end the curve would have to be numerically integrated.

A detailed explanation of the calculation can be found in the application note of Rohde & Schwarz “*Measurement of adjacent channel leakage power on 3GPP W\_CDMA signals with the FSP*”.

The next figures show an example of a  $P_{channel}$  measurement.

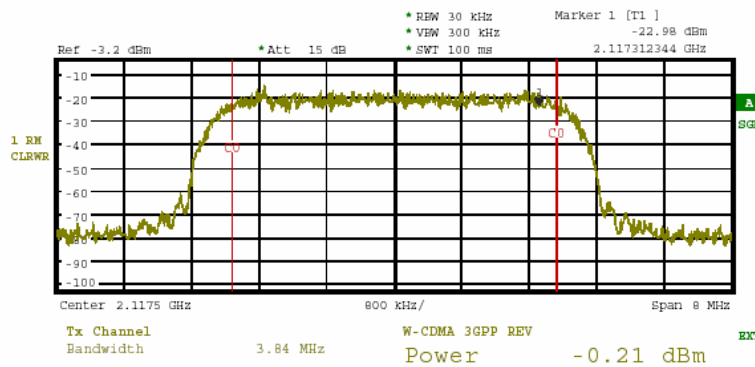

figure 10-4: UMTS channel power measurement with R&S FSQ and 3GPP option (FS-K73)

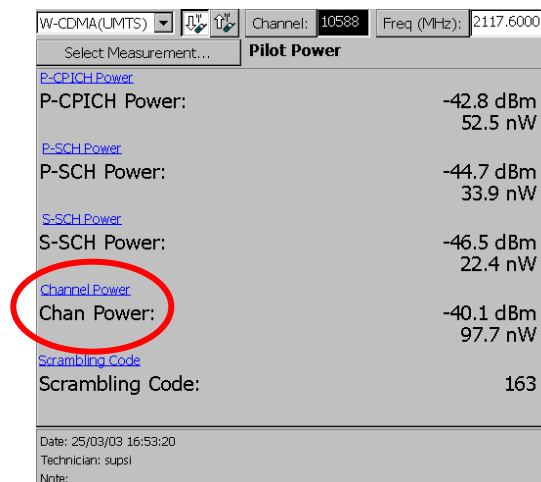

figure 10-5: UMTS channel power measurement with Tektronix YBT250



### 10.3 CPICH POWER MEASUREMENT IN THE CODE DOMAIN

In a UMTS signal it is not possible to distinguish the various control and traffic channels only on a spectral basis as this is the case for GSM signals. UMTS channels in frequency domain have a 5 MHz bandwidth and can contain the contributions of all transmitted physical channels of several cells (figure 10-6).

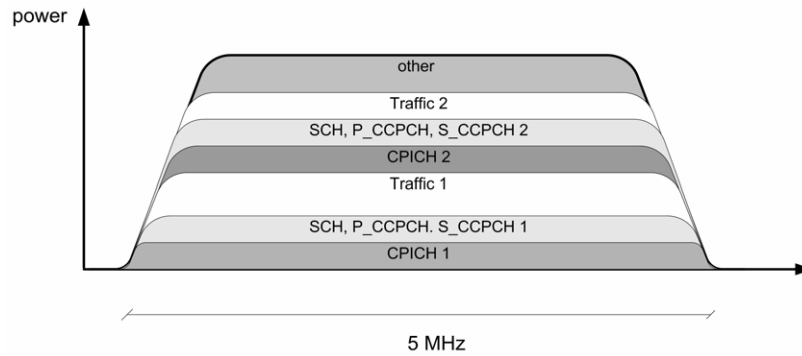

figure 10-6: WCDMA spectrum with two cells

As UMTS signals of several cells can use the same carrier frequency, the measurement system must be capable of despreading the W\_CDMA signal into its individual physical channels and measuring their power individually.

All CPICHs need to be measured separately in order to obtain a selective measurement of the electric field transmitted from a single installation. Therefore, it is necessary to have instruments which can synchronize to UMTS signals and despread the signal giving the power value for each physical channel individually. Some instruments measure and display all channels (traffic channels included), other instruments give only data regarding CPICHs.

The measurement is a digital process and the measured values are RMS values.

The measurements described in chapter 12 were performed on a test network without traffic channels. The transmitted channels of each cell were only CPICH, P\_SCH, S\_SCH and BCH. In this case where traffic channels are absent, the UMTS channel power is expected to be stable and related to the CPICH power by the following relationship:

$$P_{CPICH} [dBm] + K_{CPICH} [dB] \cong P_{channel} [dBm] \tag{10.1}$$

where  $K_{CPICH}$  is a correction factor of 1.91dB which accounts for the power contribution of the SCH and BCH channels (table 10-1; see appendix B-3 for details).

table 10-1: Power of transmitted channels referred to PCPICH (source: Swiss network provider, Swisscom AG)

Channel	Power [dBm]
$P_{CPICH}$	X
$P_{P\_SCH}$	X - 1.8 (dB)
$P_{S\_SCH}$	X - 3.5 (dB)
$P_{BCH}$	X - 3.1 (dB)

Remarks: if an instrument enables the measurement of different CPICHs, then the power of all cells must be added up and then be compared to the measured UMTS channel power.

### 10.4 MEASUREMENT EXAMPLES

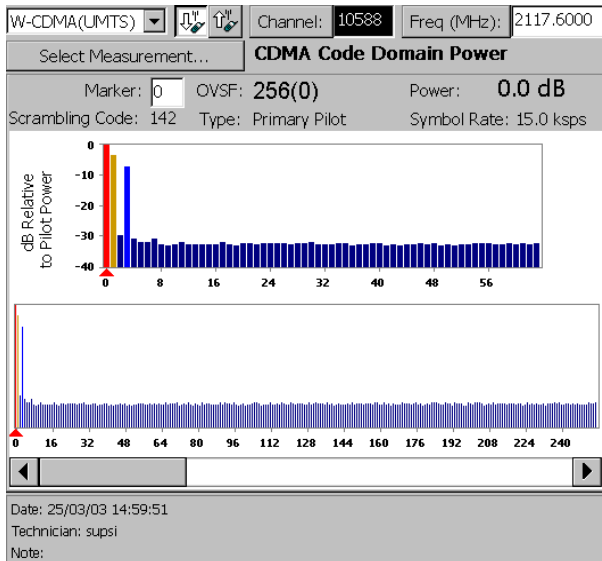

figure 10-7: Relative power measurement in code domain with Tektronix YBT250

The Code Domain Power measurement system for W-CDMA (UMTS) displays graphs that indicate the power for each Orthogonal Variable Spreading Factor (OVSF) code in the signal. Code Domain Power is displayed in two graphs. The bottom graph shows the Code Domain Power in all OVSF codes; the top graph shows a zoomed in Code Domain Power display of one fourth of the OVSF codes.

The YBT250 displays the exact power for any specified code relative to the Total Power or the Pilot Power (power in the P-CPICH channel).

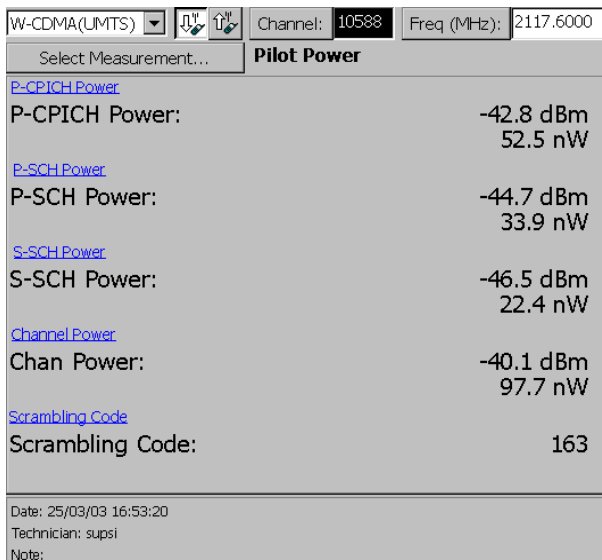

figure 10-8: Absolute power measurement in code domain with Tektronix YBT250

Pilot power is the power of the P-CPICH.

Sync power is the power of the P-SCH and S-SCH.

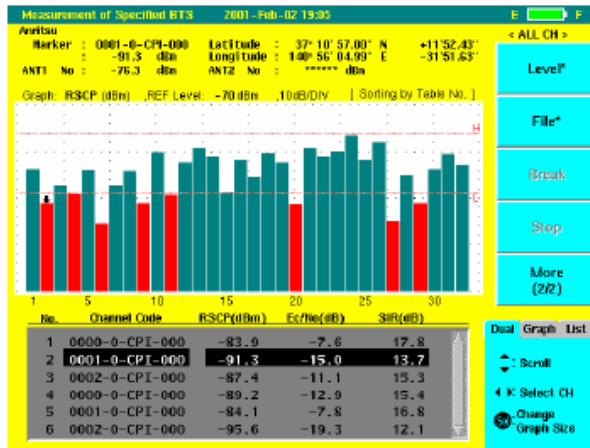

figure 10-9: Code domain measurements with Anritsu ML8720B

The measured power of all received channels (32 max.) can be simultaneously displayed as a graph and as numerical data. Additionally, the measurement interval and the processing (max., min., median, average) during this interval can be selected.

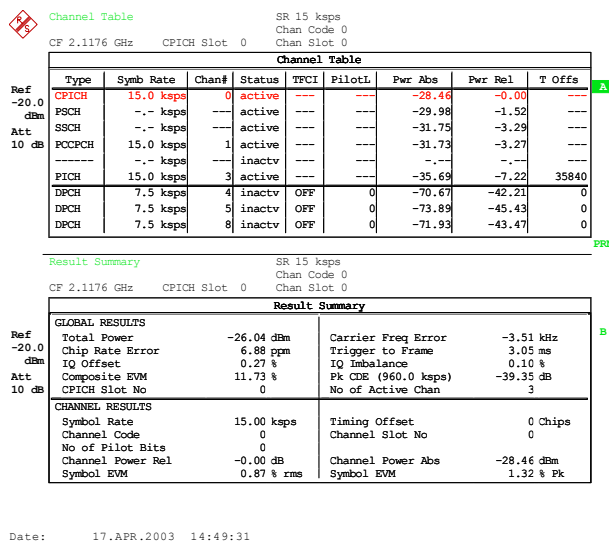

figure 10-10: CPICH power measurement with R&S FSQ

The upper part of the table indicates the DPCCH that is present in every signal to be analyzed.

The lower part of the table indicates the data channels (DPDCH) contained in the signal.

The following parameters of these channels are determined:

- Type: type of channel (active channels only),
- Symbol Rate: symbol rate at which the channel is transmitted (15 kbps to 960 kbps),
- Chan #: number of channel spreading code (0 to [spreading factor-1]),
- Status: status display. Codes that are not assigned are marked as inactive channels,
- Pwr Abs / Pwr Rel: indication of the absolute and relative channel power (referred to the CPICH or the total power of the signal).

## 11 MEASUREMENT OF UMTS SIGNALS IN THE LABORATORY

### 11.1 PURPOSE

The aim of these measurements is to measure a “real” UMTS signal in the laboratory, in order to find a valid and reproducible procedure for monitoring the electromagnetic field in closed places: particularly to validate the *Schwenkmethode*.

Practically, the intention is to produce a UMTS field in a closed room in the laboratory and characterize it in detail by mapping the field distribution. Afterwards, the *Schwenkmethode* is applied within this well defined electromagnetic environment.

The basic configuration used for producing the UMTS field is a planar antenna used as a transmitter and a reflecting metal panel located in front of the transmitter (figure 11-1). All field strength measurements are performed in the space between the transmitter and the reflecting panel at a distance of  $>10\lambda$  from the radiator. At this distance from the antenna the field is essentially of the far field type.

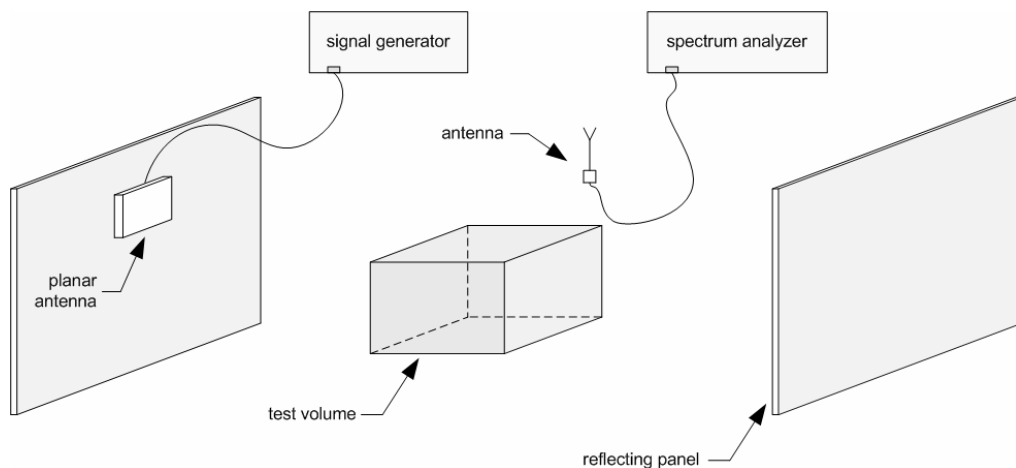

figure 11-1: Laboratory setup

#### 11.1.1 PRELIMINARY MEASUREMENTS

Preliminary measurements were performed in order to obtain a first impression of the field distribution within the test volume and to define the definitive measurement setup and procedures.

Measurements without the reflecting panel were performed first, in order to see the reflections intrinsic to the surrounding environment. Afterwards, a metallic reflecting panel was introduced creating artificial reflections.

#### 11.1.2 MAPPING THE FIELD DISTRIBUTION

The purpose of this measurement was to determine with high spatial resolution the electric field distribution within a test volume and to detect points of minimum and maximum field strength.

A test volume of a  $60 \times 60 \times 60 \text{ cm}^3$  was mapped this way by measuring power in the frequency domain ( $P_{\text{channel}}$ ) and in the codes domain ( $P_{\text{P-CPICH}}$ ).

Afterwards, the measured field distribution is graphically presented.

### 11.1.3 SCHWENKMETHODE MEASUREMENTS

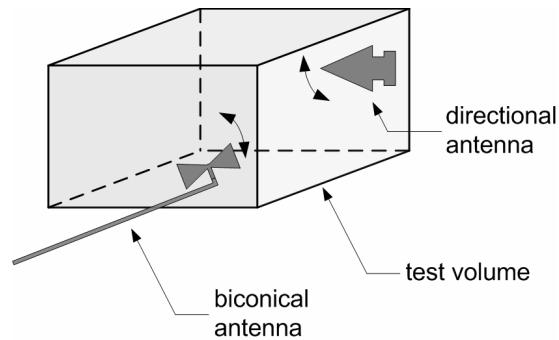

figure 11-2: *Schwenkmethode* within the test volume

The goal of the *Schwenkmethode* measurements was to check how accurately this procedure is able to identify the local field strength maximum within the previously mapped test volume.

The *Schwenkmethode* measurements were performed at different speeds and antenna polarizations inside the test volume. The measurements were performed with biconical and directional antennas that have different directional characteristics.

## 11.2 SETTING UP A CONTROLLED LABORATORY FIELD PATTERN

### 11.2.1 LABORATORY INSTRUMENTATION

The laboratory measurements were performed with the following equipment:

- signal generators - R&S SMIQ 300 KHz – 3.3 GHz (with UMTS signal generation option);
- network analyzer - Agilent PNA Series E8358A 300 KHz – 9 GHz;
- spectrum analyzers - *not specified on the public release of the report*;

antennas:

- biconical antenna - Austrian Research Centers Seibersdorf - PCD 8250;
- directional antenna - R&S - HE 200;
- 2 planar antennas - SUHNER – SPA 2400/70/9/CP;
- wire monopole antenna  $\lambda/4$ .

### 11.2.2 FIELD STRENGTH MAPPING FOR A PURE SINE WAVE

In this setup a field strength profile was measured along a line parallel to the propagation of the emitted wave as shown in figure 11-3. The distance between individual measurement points was 1 cm. The field strength profile is shown in figure 11-4.

In order to measure all the waves present at a given point, a wire monopole antenna  $\lambda/4$  was used. A directional antenna would exclude reflected signals not coming from the direction where the antenna is pointing to and was therefore not considered suitable. This  $\lambda/4$  antenna is not adapted in impedance: it has a characteristic impedance of  $Z = 30 \Omega$  on a line of  $Z_0 = 50 \Omega$ . However, this fact is not relevant for the measurement, since the measurement has a qualitative and not quantitative purpose; the measurement is needed for finding the minimum and maximum and therefore should be considered as a relative measurement and not as an absolute one.

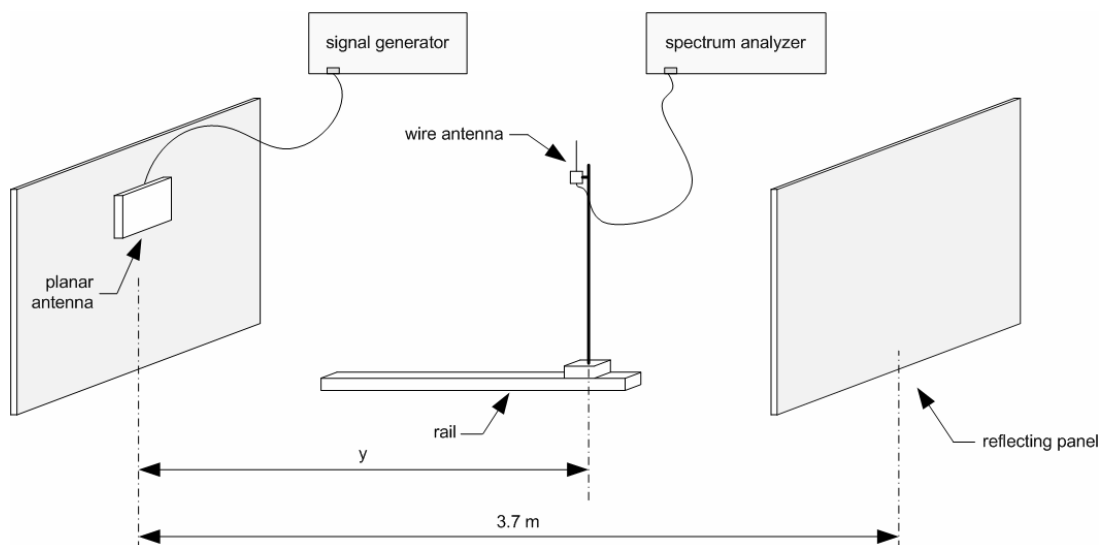

figure 11-3: Minima and maxima measurement setup

Signal: sinusoidal,  $f = 2$  (GHz),  $P_{\text{SMIQ}} = 0$  (dBm).

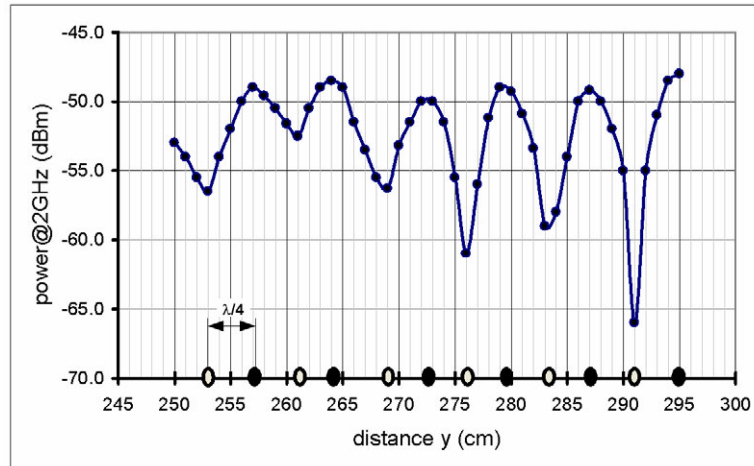

figure 11-4: Field strength profile along the line shown in figure 11-3

This simple measurement shows the field strength maxima given by signal reflections. As it can be noted in figure 11-4, the maximum points are separated by a distance of approximately 7.5 cm, corresponding to  $\lambda/2$  as expected.

### 11.2.3 INCIDENT AND REFLECTED FIELD STRENGTH OF A PURE SINE WAVE

The following measurement setup has the objective to produce field strength minima and maxima at a distance of  $\lambda/4$ : a reflecting panel has been placed perpendicularly to the propagation direction of the EM field emitted by the planar antenna, as shown by figure 11-5.

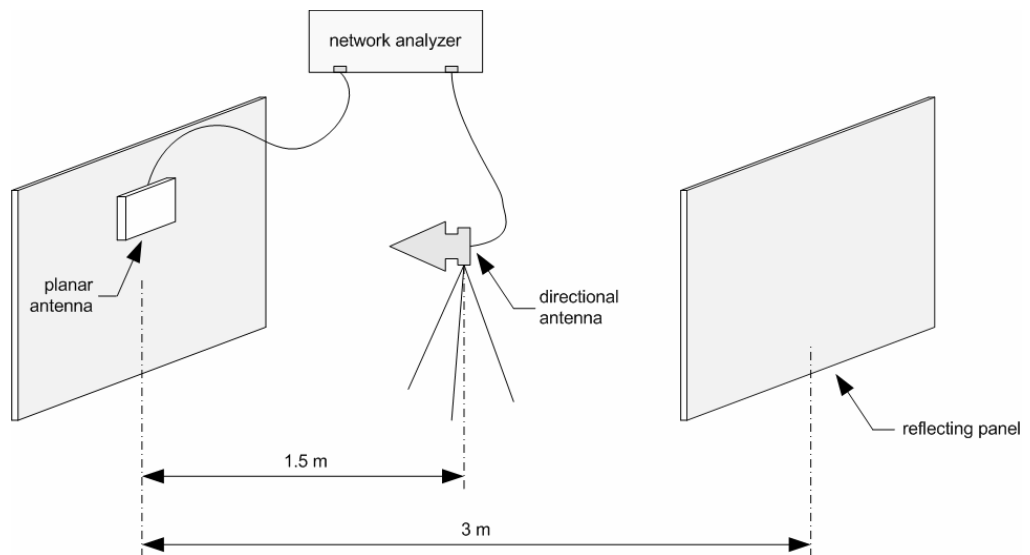

figure 11-5: Minimum and maximum - measurement setup

Before actually mapping the volume between the planar antenna and the reflector for UMTS signals we measured the contribution of the incident and reflected power of the whole system. The measurement was performed with a Network Analyzer using the four experimental settings shown in figure 11-6 and measuring the parameter  $S_{21}$ <sup>2</sup>. The resulting spectra for the four set ups are shown in figure 11-7.

<sup>2</sup>  $S_{21}$  is the transmission coefficient: it is a measure of the energy transmitted through a 2-port system.

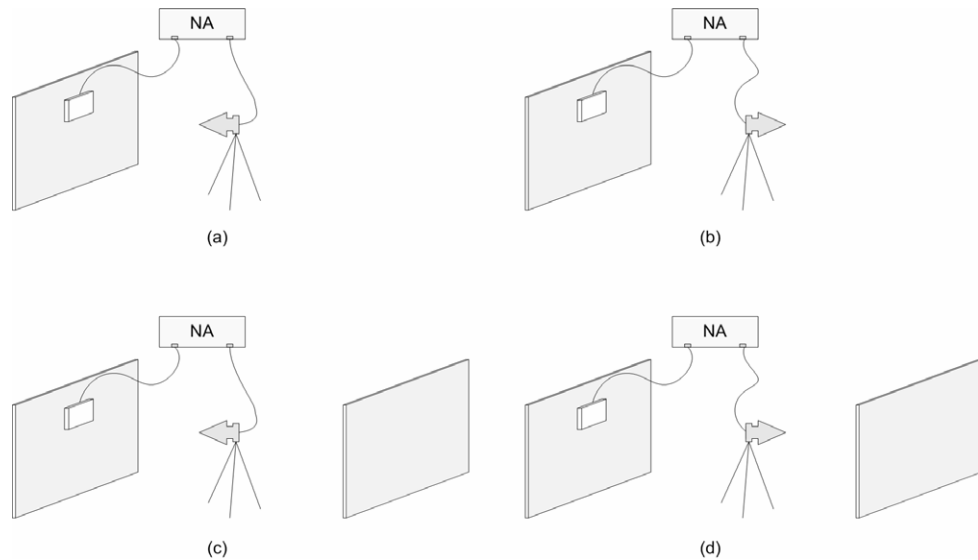

figure 11-6: Experimental setup for measurement of incident and reflected power

- a) without reflecting panel, RX antenna directed to TX antenna (direct 1)
- b) without reflecting panel, RX antenna directed away from TX antenna (reflected 1)
- c) with reflecting panel, RX antenna directed to TX antenna (direct 2)
- d) without reflecting panel, RX antenna directed away from TX antenna (reflected 2)

The figure 11-7 shows that the incident power does not significantly change when the reflecting panel is inserted. On the contrary, the reflected power increases after insertion of the reflecting panel.

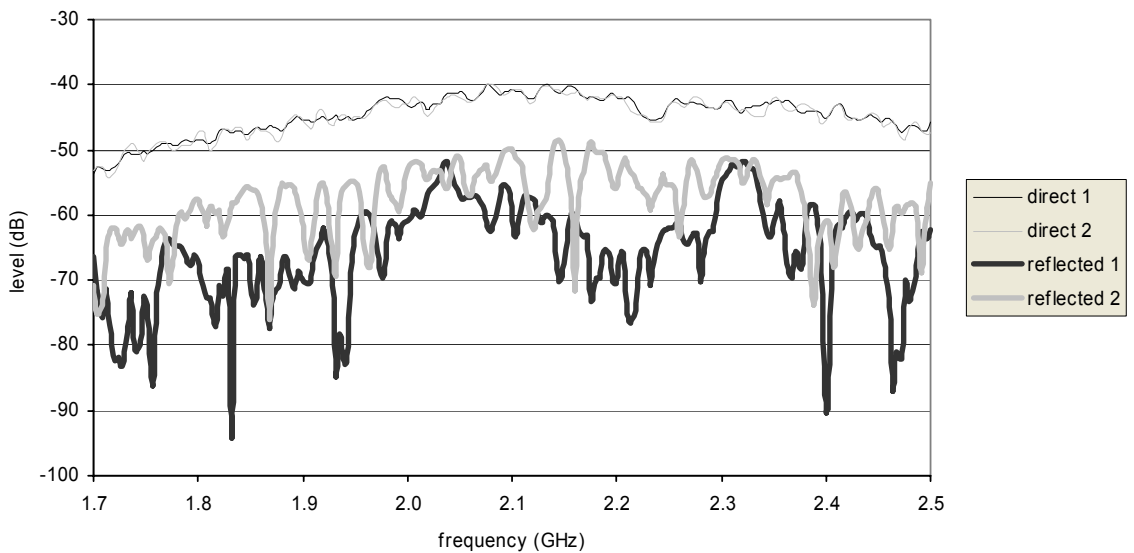

figure 11-7: Direct and reflected wave measurement (S21 parameter)



## 11.2.4 UMTS SIGNAL MEASUREMENT IN THE FREQUENCY DOMAIN

The purpose of this measurement series is to demonstrate the measurement of UMTS signals in the frequency domain in a laboratory set up.

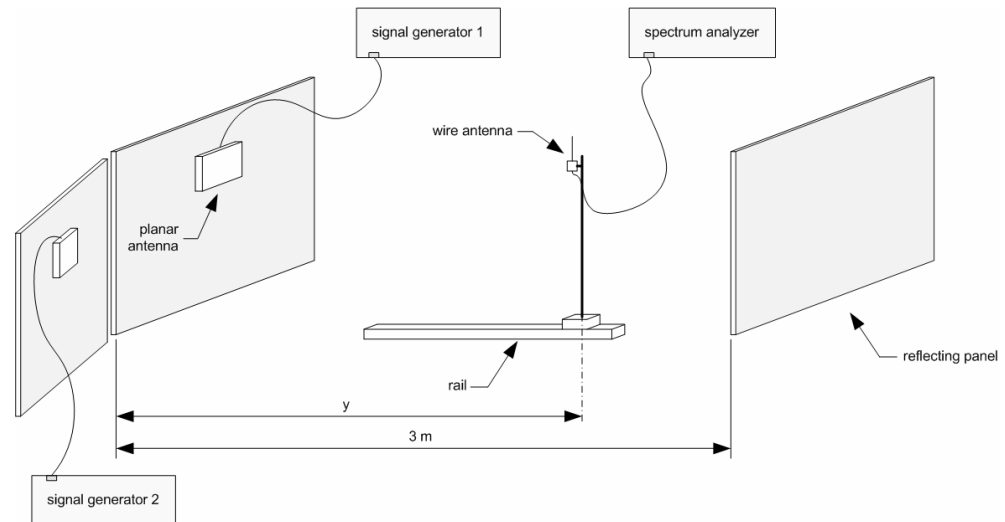

figure 11-8: Measurement setup

In order to measure two different cells, two UMTS (R&S SMIQ) signal generators on two different carriers are used. The figure 11-8 shows the measurement setup.

The generator SMIQ allows producing UMTS test signals. The following parameter sets were used for the simulation:

- TEST1\_16: 16 traffic channels, 6 service channels;
- TEST1\_32: 32 traffic channels, 6 service channels;
- TEST2 : 3 traffic channels, 6 service channels.

### Frequency domain measurement

$y = 1.92$  (m)

SMIQ1 2.000 (GHz), PSMIQ1 = 0 (dBm), TEST1\_16

SMIQ2 2.005 (GHz), PSMIQ2 = 0 (dBm), TEST1\_32

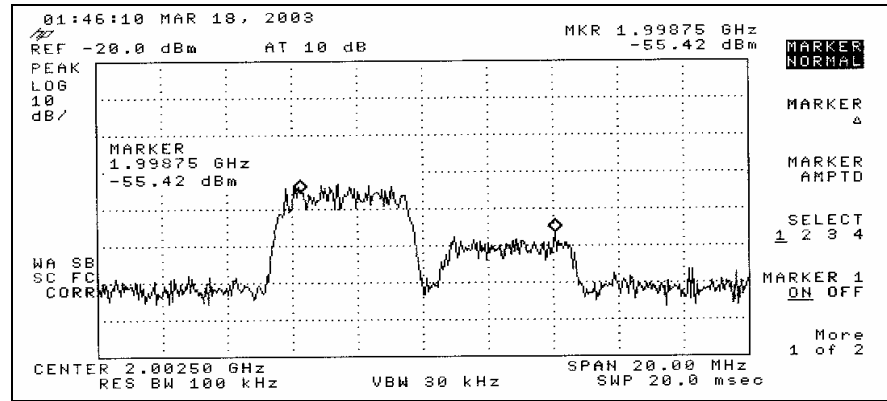

figure 11-9: UMTS signal - 2 cells at different carrier frequency

The figure 11-9 shows two UMTS signals modulated on two different carriers. Although the emitted power is equal for the two carriers the measured field strength differs by approximately 10 dB. This difference is due to signal reflections and standing waves which are at different positions for the two carriers.

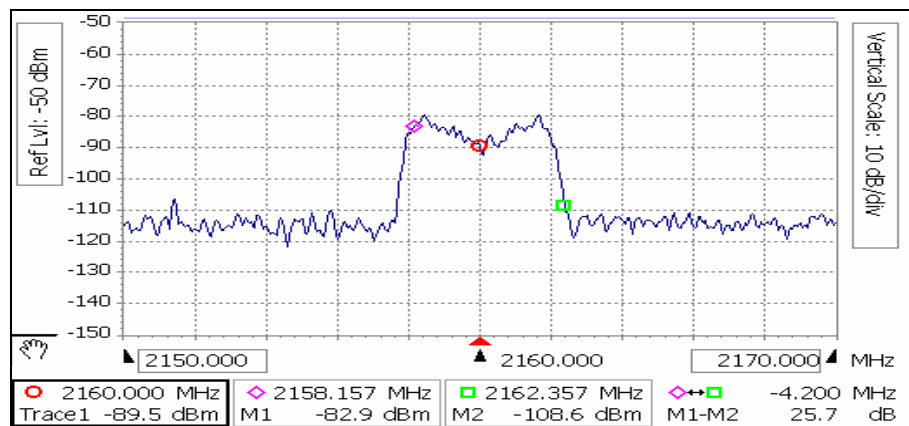

figure 11-10: Distorted signal due to a reflection

In case of strong reflections the UMTS signal spectrum (“bell”) becomes distorted as shown in figure 11-10. This is due to the sum of different reflections (multipath). However, there are no important changes to the overall power within the whole UMTS channel.

## 11.3 MAPPING OF THE FIELD PATTERN

### 11.3.1 FIELD STRENGTH MAPPING OF A SYNTHETIC UMTS SIGNAL

The purpose of this measurement series is to map the field distribution of a synthetic UMTS signal within a test volume of  $60 \times 60 \times 60 \text{ cm}^3$  in the presence of a reflecting panel. The measurement setup is shown in figure 11-11. A UMTS signal with the following characteristics was synthesized:

SMIQ  $f = 2.16$  (GHz),  $P_{\text{SMIQ}} = 0$  (dBm), WCDMA/3GPP  $\rightarrow$  TEST\_2

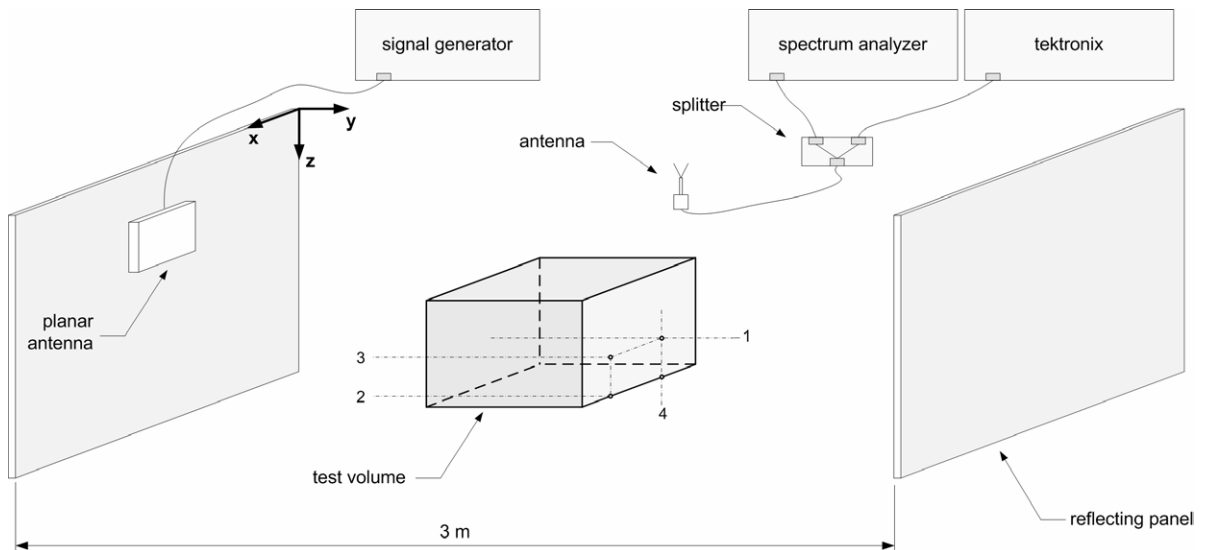

figure 11-11: Measurement setup and coordinate system

### 11.3.2 PROFILES OF CPICH POWER ALONG HORIZONTAL AND VERTICAL LINES

Three profiles of primary CPICH-power were recorded horizontally along the y-axis at intervals of 2 cm. First, without the reflecting panel, and then with the panel in place. x- and z- coordinates were fixed at the following values:

- $x = 30$  cm,  $z = 10$  cm;
- $x = 50$  cm,  $z = 10$  cm;
- $x = 50$  cm,  $z = 30$  cm.

A fourth profile was taken vertically at the following x- and y positions:

- $x = 30$  cm,  $y = 200$  cm.

The measurements were performed with the wire antenna. The horizontal CPICH profiles without and with reflecting panel are shown in figure 11-12 and figure 11-13, the vertical profile with reflecting panel in figure 11-14. Tables with all measured values are compiled in "Appendix A – Laboratory measurements".

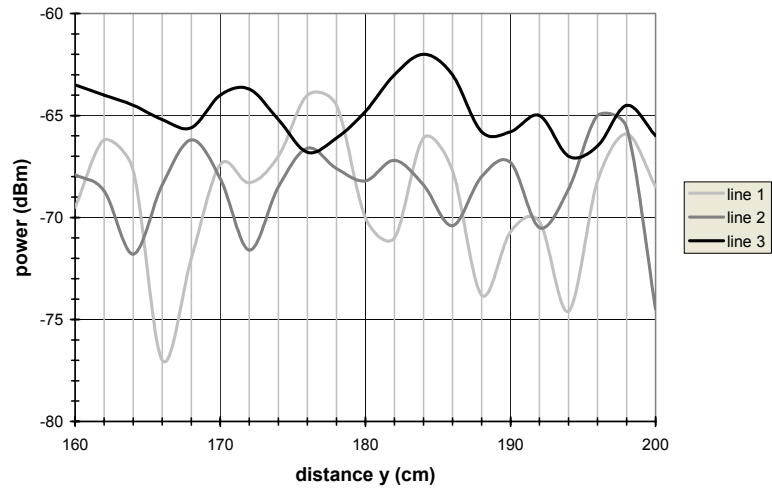

figure 11-12: P-CPICH power measured along 3 horizontal lines in the absence of a reflecting panel

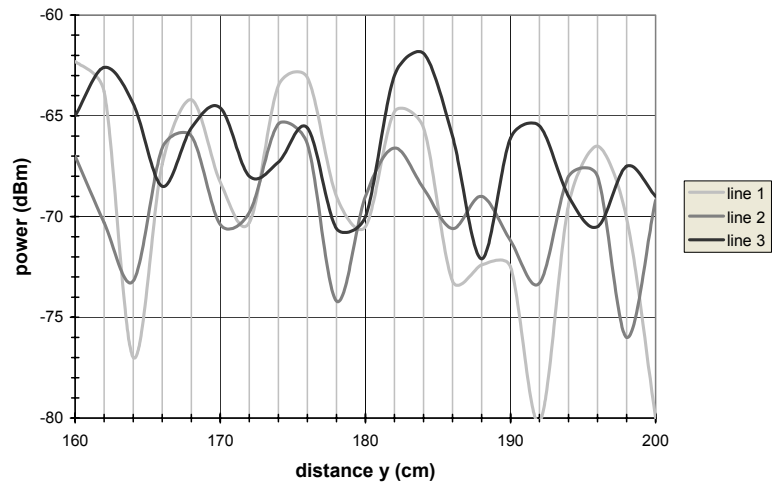

figure 11-13: P-CPICH power measured along 3 horizontal lines in the presence of a reflecting panel

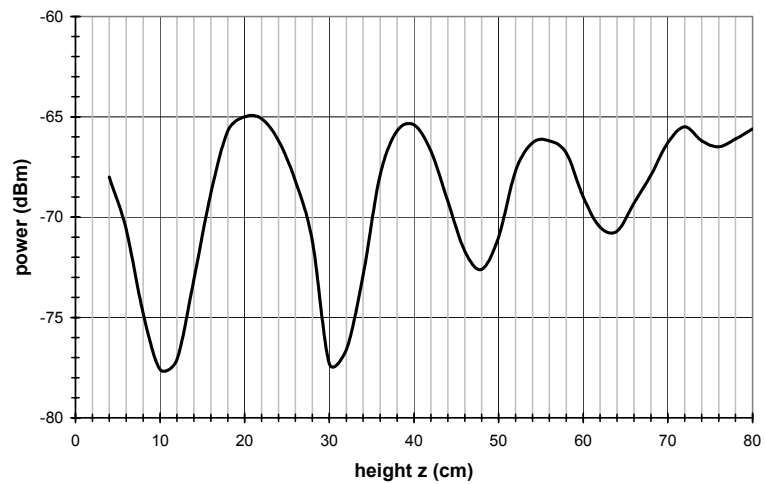

figure 11-14: P-CPICH power measured along a vertical line in the presence of a reflecting panel

From the figures above it can be seen that, already without the reflecting panel, there are some rather irregular maxima and minima, due to the room configuration that gives rise to multiple reflections. Repeating the measurement with the reflecting panel (figure 11-13), the maxima/minima become more pronounced and appear almost in phase for the 3 profiles: this means that the reflections are mainly due to the panel.

The figure 11-14 represents the measurement performed on the vertical axis. In this case, maxima and minima are not at a regular distance of  $\lambda/4$ : their separation is a function of the measurement's height as shown in figure 11-15.

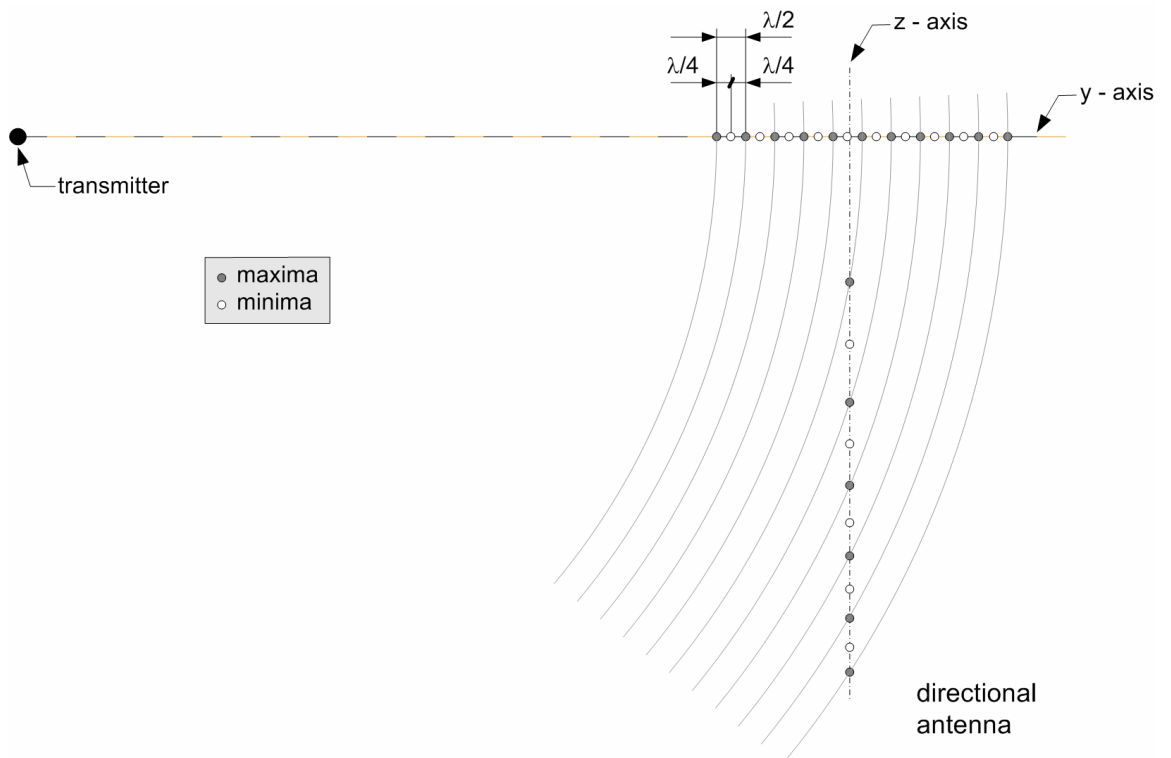

figure 11-15: Maxima/minima in front of a transmitter

### 11.3.3 REFERENCE MEASUREMENTS OF CPICH AND UMTS-CHANNEL POWER WITH A BICONICAL ANTENNA

Grid measurement have been performed on three parallel planes, at different heights (separated by 20 cm), mapping a surface of 60x60 cm<sup>2</sup> on a grid of 2x2 cm<sup>2</sup>. During the measurements the antenna polarization was kept fixed as shown in figure 11-16.

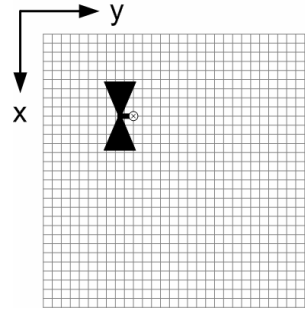

figure 11-16: Measurement surface and biconical antenna orientation

The transmitted power has been increased to  $P_{SMIQ} = 16$  dBm in order to enable the decoding of the UMTS signal also at points of field strength minima.

The following measurements have been performed:

- In the code domain → P\_CPICH power ( $P_{P\_CPICH}$ );
- In the frequency domain → UMTS Channel Power ( $P_{channel}$ ).

Figures 11-17 to 11-19 show the results for the P-CPICH power. The results for the UMTS-channel power are not presented graphically: they are generally 10 dB higher than P-CPICH power (as set on the SMIQ) and show a similar spatial pattern.

The details of all measurements appear in “Appendix A – Laboratory measurements”.

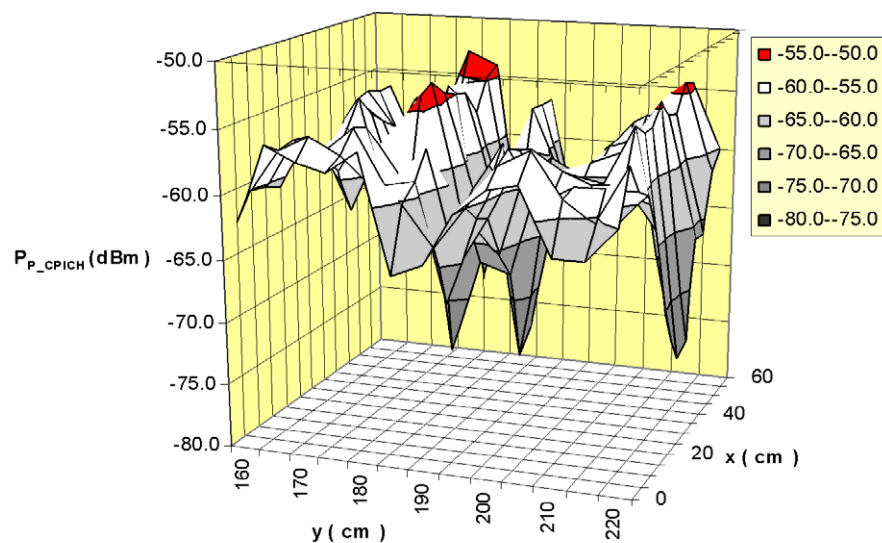

figure 11-17: P-CPICH power measured at height  $z = 10$  cm

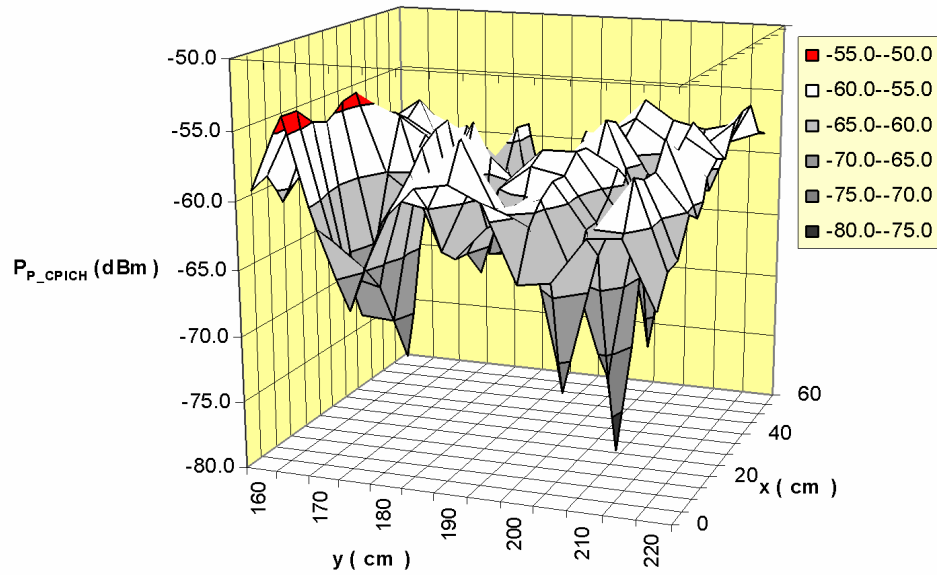

figure 11-18: P-CPICH power measured at height z = 30 cm

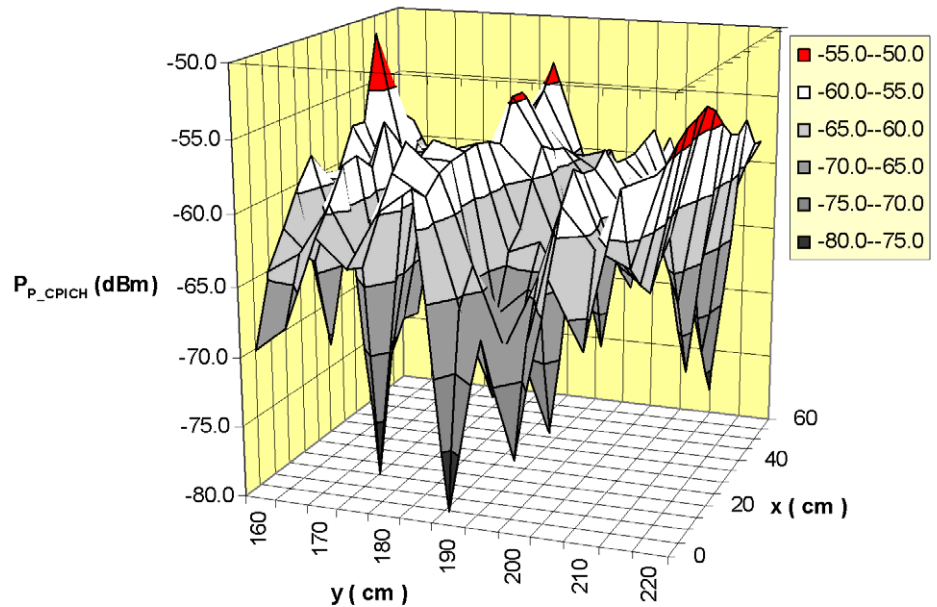

figure 11-19: P-CPICH power measured at height z = 50 cm

In the above figures pronounced minima and maxima can be distinguished. Let's remark that the positions of the maxima and minima as well as their absolute values remain essentially the same in the three respective planes. The table 11-1 shows the global maximum and minimum values for all three planes, both for P-CPICH power and for UMTS-channel power.

table 11-1: Global maximum and minimum values measured with the biconical antenna

	$P_{P\_CPICH}$ (dBm)	$E_{P\_CPICH}$ (V/m)	$P_{channel}$ (dBm)	$E_{channel}$ (V/m)
max	-51	0.0636	-43	0.1598
min	-79	0.0025	-68	0.0090

### 11.3.4 REFERENCE MEASUREMENTS OF CPICH AND UMTS-CHANNEL POWER WITH A DIRECTIONAL ANTENNA

In this measurement, the same setup as for the measurement with the biconical antenna was used. The measurement was however performed with a directional antenna, oriented along the y-axis (to the transmitter) and moved by free-hand on the three planes described by chapter (11.3.3). The table 11-2 shows the global maximum field strength detected with the directional antenna.

table 11-2: Global maximum values measured with the directional antenna

	$P_{P\_CPICH}$ (dBm)	$E_{P\_CPICH}$ (V/m)	$P_{channel}$ (dBm)	$E_{channel}$ (V/m)
max	-34.5	0.0644	-24.5	0.2039

Let's remark that the field strength of the  $P_{CPICH}$  measured with the directional antenna is close to the one measured with the biconical, while for  $E_{channel}$  there is a deviation of 25% which however is still within the instruments measurement uncertainty (2 dB).

## 11.4 MEASUREMENT OF THE CHARACTERIZED FIELD PATTERN WITH *SCHWENKMETHODE*

The purpose of the measurement is to evaluate the *Schwenkmethode*, using different antennas, polarizations and sweeping speeds. The table 11-3 summarizes the global maxima obtained with the high resolution grid mapping which should ideally be detected also by the *Schwenkmethode*.

table 11-3: Global maximum values measured on the grid inside the test volume

	$P_{P\_CPICH}$ (dBm)	$P_{channel}$ (dBm)
biconical antenna	-51.0	-43.0
directional antenna	-34.5	-24.5

The table 11-4 specifies the equipment used for the test of the *Schwenkmethode*, the related measurement uncertainty and the sampling rate for code domain measurements.

table 11-4: Equipment characteristics for testing the *Schwenkmethode*

	amplitude uncertainty	sampling rate
instr#D	± 0.2 dB	0.2 sa/s
instr#C	± 1.0 dB	< 1 sa/s
instr#F	± 1.5 dB	3.3 sa/s



### 11.4.1 MEASUREMENT SCHEME

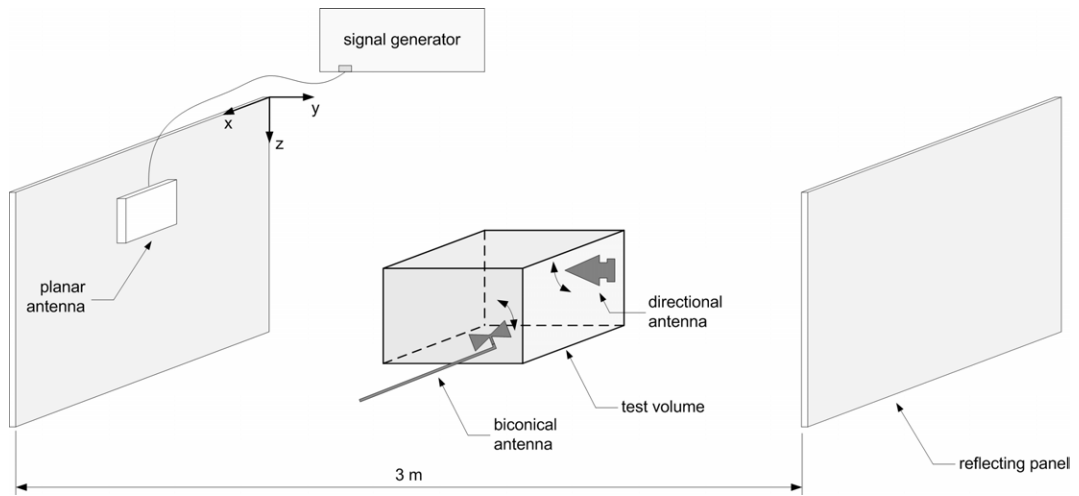

figure 11-20: *Schwenkmethode* measurement setup

Measurements were performed both in the code and frequency domain, with three different sweeping speeds. The figure 11-21 and the figure 11-22 give an overview of the various measurements performed with the biconical and the directional antenna respectively.

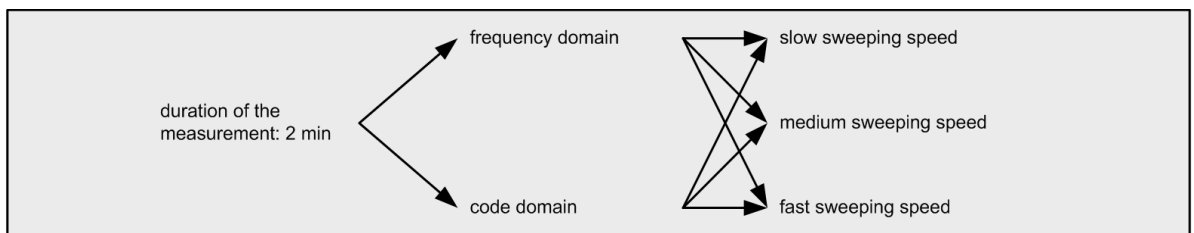

figure 11-21: *Schwenkmethode*, biconical antenna

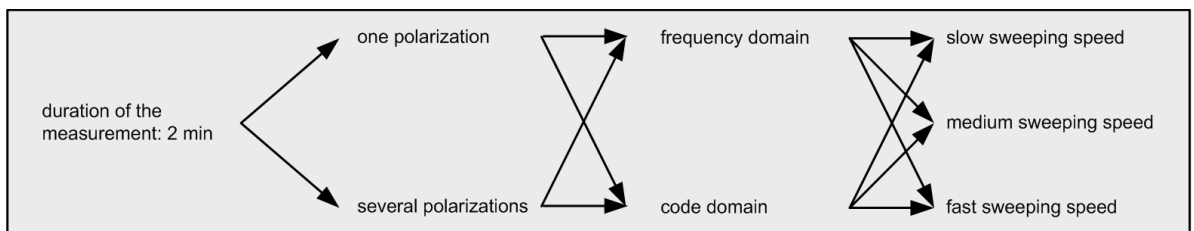

figure 11-22: *Schwenkmethode*, directional antenna

The sweeping speed is defined as follows:

- slow: ~ 0.08 (m/s)
- medium: ~ 0.16 (m/s)
- fast: ~ 0.50 (m/s)

With the directional antenna two measurement series were performed, one with single polarization and the other with several polarizations.

The directional antenna has the advantage of excluding the reflections given by the operator which is not the case with the biconical antenna. In order to minimize field distortions by the operator the biconical antenna was mounted on a wooden stick of about 1.5 m length.

The figure 11-23 shows the antenna movement during a *Schwenkmethode* measurement: the biconical antenna (a) is kept parallel to the x-axis and to the xy-plane, while the directional antenna (b) is kept as best as possible parallel to the y-axis and parallel to the xy-plane. Otherwise, the displacement is random-like, across the whole test volume.

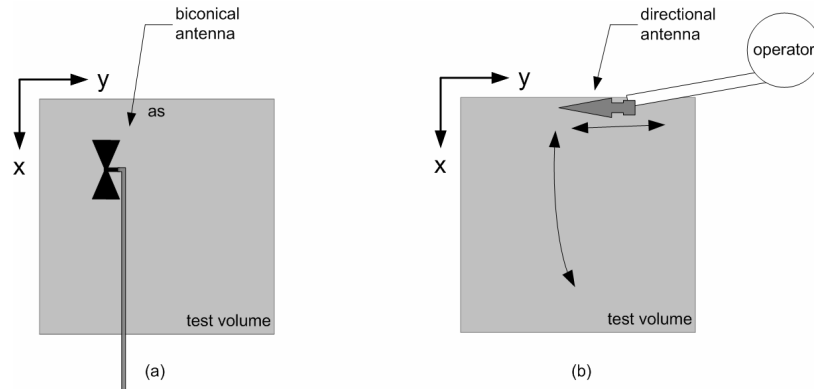

figure 11-23: *Schwenkmethode* movement

An estimate of the number of samples per meter of antenna movement is given in table 10-5 for the three sweeping speeds and instruments used.

table 11-5: Sampling rate (number of samples per meter of antenna movement; sa/m)

sweeping speed	instr#D (sa/m)	instr#C (sa/m)	instr#F (sa/m)
low	2.5	12.5	41.7
medium	1.25	6.25	20.83
high	0.4	2	6.7

From table 11-5 it could be expected that the global maximum field strength should most conveniently and reliably be detectable with the instr#F at low sweeping speed, because this setup provides the highest sampling rate per meter.

#### 11.4.2 MEASUREMENT RESULTS

All measurements with the *Schwenkmethode* have been repeated three times for each individual measurement procedure/configuration. For comparison with the expected global maximum according to table 11-3 only the highest value of the three independent measurements has been kept. The deviation between the highest value obtained by the *Schwenkmethode* and the expected value is visualized in figures 11-24 to 11-31.

The figure 11-24 shows the deviation for  $P_{P\_CPICH}$ , for each instrument and sweeping method, figure 11-28 shows the deviation for  $P_{channel}$ .

Afterwards, the same data are rearranged and sorted by acquisition speed (sa/m). These graphs have been separated for each antenna type.

The observed deviations are due to the following reasons:

- instrument uncertainty
- instrument synchronization problems in the codes domain
- antenna potentially outside the test volume
- influence on the measurement by the operator
- sampling speed

**DEVIATION OF  $P_{P\_CPICH}$  IN DEPENDENCE OF THE DATA ACQUISITION RATE (SA/M)**

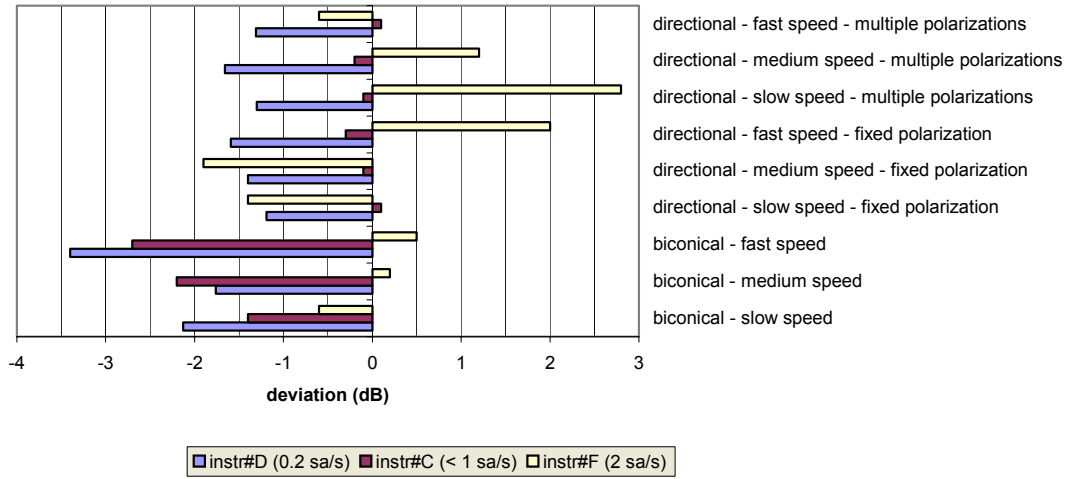

figure 11-24:  $P_{P\_CPICH}$ : deviation from global maximum; all data

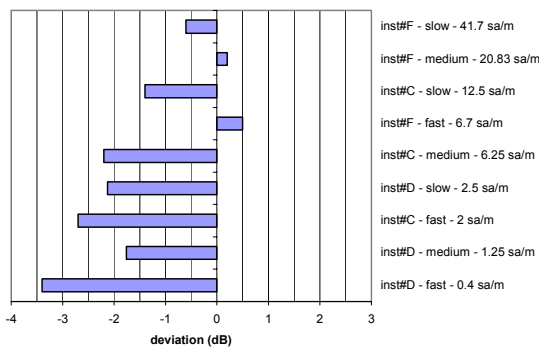

figure 11-25:  $P_{P\_CPICH}$ : deviation from global maximum; biconical antenna

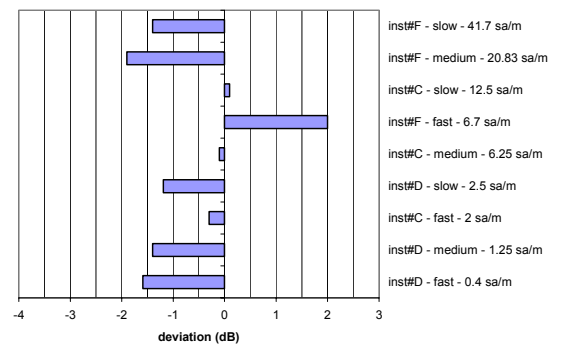

figure 11-26:  $P_{P\_CPICH}$ : deviation from global maximum; directional antenna, single polarization

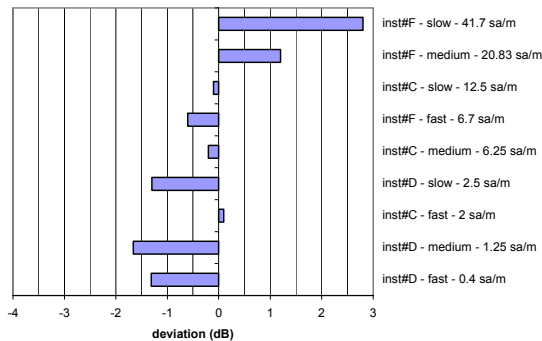

figure 11-27:  $P_{P\_CPICH}$ : deviation from global maximum; directional antenna, multiple polarizations

**DEVIATION OF  $P_{CHANNEL}$  IN DEPENDENCE OF THE DATA ACQUISITION RATE (SA/M)**

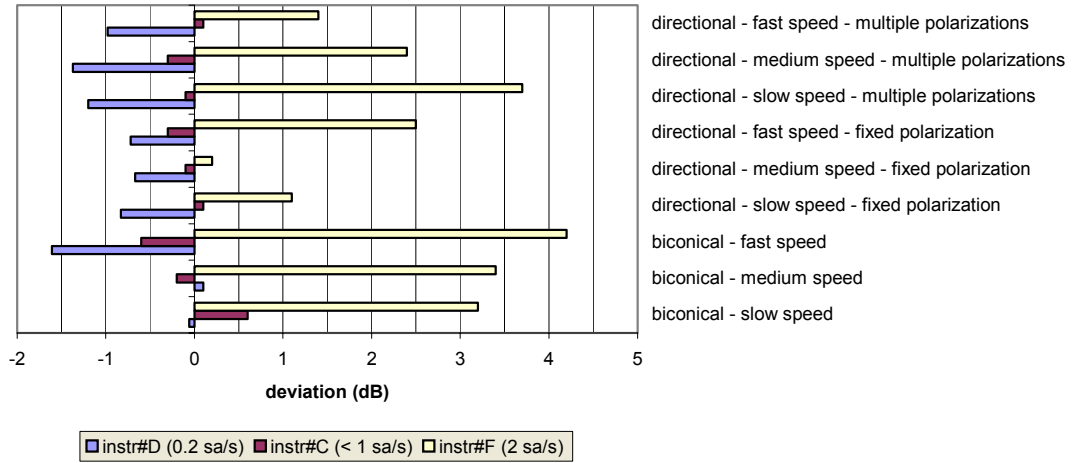

figure 11-28:  $P_{channel}$ : deviation from global maximum; all data

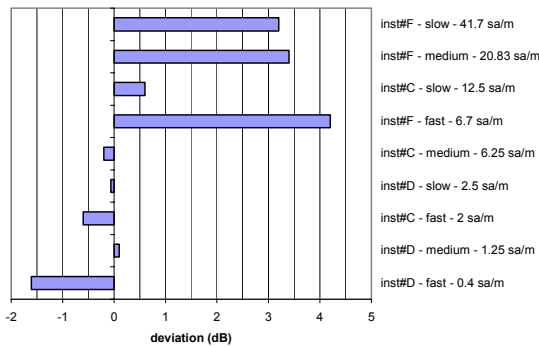

figure 11-29:  $P_{channel}$ : deviation from global maximum; biconical antenna

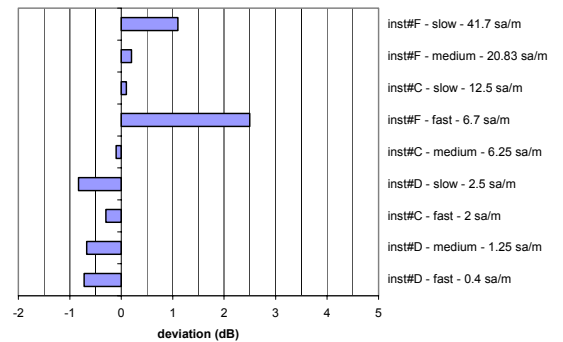

figure 11-30:  $P_{channel}$ : deviation from global maximum; directional antenna, fixed polarization

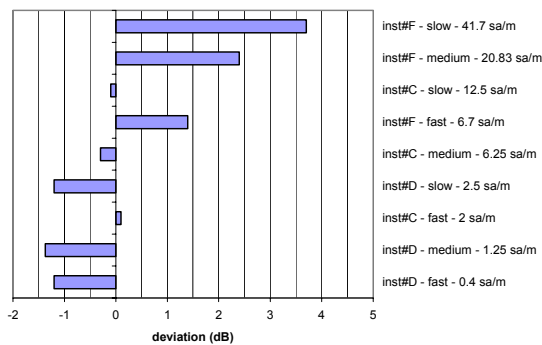

figure 11-31:  $P_{channel}$ : deviation from global maximum; directional antenna, multiple polarizations

### **COMMENT ON USED INSTRUMENTS**

The histograms above generally indicate a good performance of the *Schwenkmethode* with the applied instruments. In fact the maximum values detected by means of the *Schwenkmethode* are within 1-2 dB from the expected global maximum (see table 11-3).

The only exception is the instr#F, which in the majority of measurements gives too high values. In fact, the laboratory and on-field measurements show that instr#F cannot be considered reliable. Systematic measurement errors were detected and were also acknowledged by the software developer. Therefore, for the further analysis all the measurements performed by means instr#F were excluded.

It should be recalled that the grid mapping measurements which provide the reference for the global maximum were performed by means of the instr#C instrument. It is therefore expected that the *Schwenkmethode* should give the smallest deviation if performed with the same instrument. This is indeed found. In addition, for this instrument, the sweeping speed seems not to be relevant for the maximum value determination. However, during the high speed sweeping, in comparison to the slower one, a serious synchronization problem of the measuring instruments was noticed which could be related to the low signal levels.

### **DIRECTIONAL VERSUS BICONICAL ANTENNAS**

With the biconical antenna (figure 12-25) a smaller deviation is obtained by increasing the data acquisition rate of the instrument (sa/m).

With the directional antenna it has been possible to find the expected global maximum with a deviation smaller than 2 dB. The antenna polarization – whether fixed or variable during the sweep – seems not to influence the result (see figure 11-26, figure 11-27). Nevertheless, measurements with fixed polarization have limitations in case of particular reflections and consequently it is preferred and advisable to choose an antenna rotation method.

### **CPICH POWER VERSUS UMTS CHANNEL POWER**

Apparently, the measurement of the UMTS channel power (figure 11-29, figure 11-30 and figure 11-31) is reliable: the deviation is smaller than 1.7 dB. This measurement has the advantage that it may be performed by means of a common spectrum analyzer.

The measurements of the CPICH power in the code domain show that there is a difference between the biconical and directional antenna measurements: with the directional one the deviation is smaller than 2 dB, while the deviation obtained with the biconical antenna is up to 3.4 dB. Let's remark that, because of the different antenna factors, the measured power of the biconical antenna is 15-20 dB lower than with the directional one, which might cause synchronization problems and therefore reduce the measurement quality.

## 11.5 REMARKS AND CONCLUSIONS ON THE FEASIBILITY OF THE *SCHWENKMETHODE*

The purpose of this measurement series was to extend the *Schwenkmethode*, which is commonly used for GSM measurements, to the measurement of UMTS signals. Measurements were performed in an environment with signal reflections, for which the maximum and minimum points of the electric field inside a defined test volume had previously been systematically determined.

In order to validate the *Schwenkmethode*, a measurement series was performed inside the same previously mapped volume, using the following setups: measurement with biconical antenna, with directional antenna with single and multiple polarizations. These measurements were performed with slow, medium and high sweeping speed.

For each trial the deviation of the maximum value detected by means of the *Schwenkmethode* with respect to the reference global maximum was calculated. The largest deviations, excluding those resulting from the faulty instr#F, are listed in table 11-6.

table 11-6: Maximum deviations obtained with the *Schwenkmethode*

	deviation for $P_{P\_CPICH}$ (dB)	deviation for $P_{channel}$ (dB)
biconical antenna	< 3.4	< 1.6
directional antenna (single polarization)	< 2.0	< 0.8
directional antenna (multiple polarizations)	< 1.7	< 1.4

Taking into consideration the measurement uncertainties due to the instruments accuracy, the *Schwenkmethode* gives good results. The laboratory trials show that – in terms of reproducibility - this is a valid procedure to find and measure the field strength maxima in a given volume also for UMTS signals.

In order to discriminate one cell from the other cells on the same carrier, the measurement must be performed in the code domain (CPICH power) and the scrambling codes should be known. Moreover, the instruments should be provided with “max hold” functions.

The measurement should be performed by moving the antenna into all its polarization directions and measuring the  $P_{CPICH}$  power (eventually UMTS channel power, too). The sweeping speed, within the analyzed limits, is not a determinant parameter for both instruments.

To obtain a high quality measurement, longer measurement time should be foreseen in comparison with those used for the laboratory trial, for instance 6-8 minutes, because with instruments having slow data acquisition time, the reliability does increase.

Generally, the lower the instruments data acquisition rate, the more time should be provided for data acquisition.

It is advisable to first identify the area where the field maximum is located and then to examine in detail only this area.

Noticed problem: the instr#F is not reliable because of software problems. This problem was confirmed by the manufacturing company.

## 12 ON-SITE MEASUREMENTS

In this chapter, the measurement sessions outside the laboratory, in the neighborhood of real UMTS antennas are described. These installations were antennas of the Swisscom test network, with few or inexistent user traffic.

The goals of these on-site measurements made with real UMTS installations are the following:

- test and comparison of different measurement instruments,
- reproducibility tests,
- comparison of the spectral measurements performed with RBW of 1 MHz and 5 MHz,
- comparison of spectral, UMTS channel power and CPICH power measurements,
- application and validation of the *Schwenkmethode*.

The determination of the contributions of several UMTS installations was also considered, however the signals of all but the nearest installation were very weak due to the considerable distance.

Field measurements have been performed both at fixed points (antenna on a tripod) and inside a measurement volume surrounding the fixed points (*Schwenkmethode*).

To describe the location where the fixed point measurements were performed, the coordinate system explained in figure 12-1 is used:  $x, y, z$  are the coordinates of the tripod;  $x_1, y_1, z_1$  are the coordinates of the antenna tip. For outdoor measurements, only  $z$  and  $z_1$  are given (the antenna is always directed towards the installation).

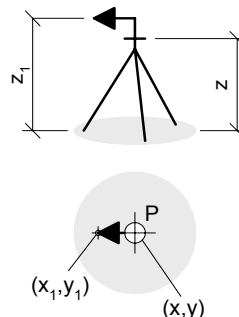

figure 12-1: Coordinates system (tripod and antenna)

At each location the following steps were carried out:

- measurement with an isotropic probe exploring the entire measurement volume in order to identify local maxima;
- verification of the local maximum using a receiver and an antenna, thereby considering only the electrical field generated by the UMTS installation and not by other sources as with the wideband probe (let's remark that this local maximum does not necessarily represent the absolute maximum);
- fixed point measurement on tripod;

*Schwenkmethode* measurement within the volume surrounding the fixed point of measurement (figure 12-2).

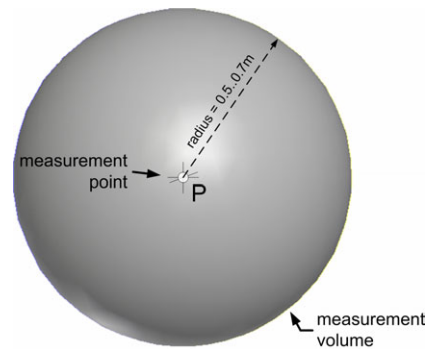

figure 12-2: Schwenkmethode measurement volume

## 12.1 INSTALLATIONS

Installations have been chosen according to the on-site measurement objectives. It was important to find measurement sites with easy accessibility, allowing indoor and outdoor measurements.

The installations chosen for the measurements are represented on the map of Bern town (figure 12-3). The installations taken into account are:

- BEFH Bern – Forsthaus, Murtenstrasse 94
- ITTI Ittigen, Ey 8
- BEGF Bern – Galgenfeld, Zikadenweg 35
- KONI Köniz, Wabersackerstrasse 34



figure 12-3: Map of the installations, town of Bern



### 12.1.1 BEFH INSTALLATION

Measurements at the installation BEFH were performed only outdoor. The distance between the point of measurement and the antenna was about 130 m. At BEFH only reproducibility measurements were performed.

table 12-1: Location of the installation BEFH

address	Bern – Forsthaus, Murtenstrasse 94
acronym	BEFH
longitude	N 46°57'11.52"
latitude	E 07°25'06.71"

table 12-2: Technical data of the installation BEFH

cell ID	azimuth (°)	sector width (°)	SC	channel	f (MHz)	P <sub>CELL,max</sub> (dBm)	P <sub>CPICH</sub> (dBm)
BEFH1G	0	65	151	10588	2117.6	43	27
BEFH2G	120	65	152	10588	2117.6	43	27
BEFH3G	240	65	153	10588	2117.6	43	27

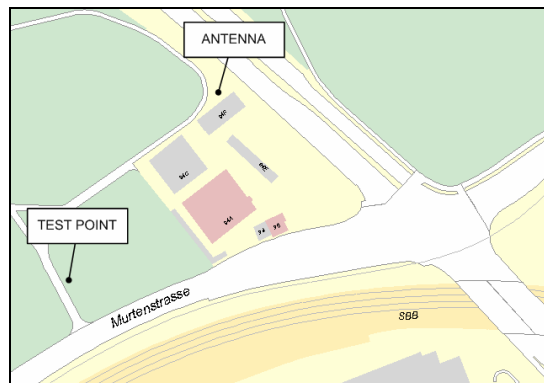

figure 12-4: Map of BEFH installation



figure 12-5: View of the BEFH installation



figure 12-6: View of the point of measurement at BEFH

### 12.1.2 ITTI INSTALLATION

Measurements at the installation ITTI were performed indoor. The distance between the point of measurement and the antenna was about 400 m.

table 12-3: Location of the ITTI installation

antenna	address	Ey 8, Ittigen
	acronym	ITTI
	longitude	N 46°58'31.44"
	latitude	E 07°28'18.30"
point of measurement	address	Sitzungszimmer 306, Papiermühlestrasse 172, Ittigen

table 12-4: Technical data of the ITTI installation

cell ID	azimuth (°)	sector width (°)	SC	channel	f (MHz)	P <sub>CELL,max</sub> (dBm)	P <sub>CPICH</sub> (dBm)
ITTI1G	0	65	141	10588	2117.6	43	27
ITTI 2G	100	65	142	10588	2117.6	43	27
ITTI 3G	240	65	143	10588	2117.6	43	27

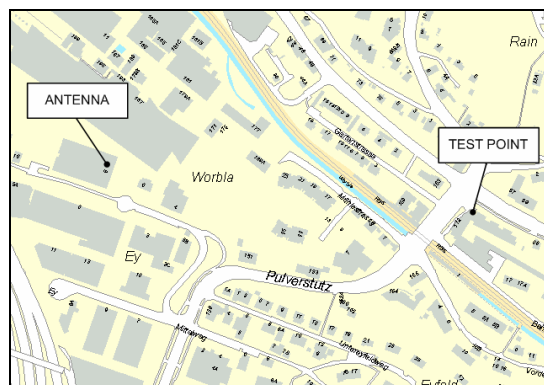

figure 12-7: Map of ITTI installation



figure 12-8: View of the ITTI installation



figure 12-9: View of the BUWAL building where the indoor measurements were performed



figure 12-10: Indoor view of the point of measurement



figure 12-11: View of the antenna at the point of measurement

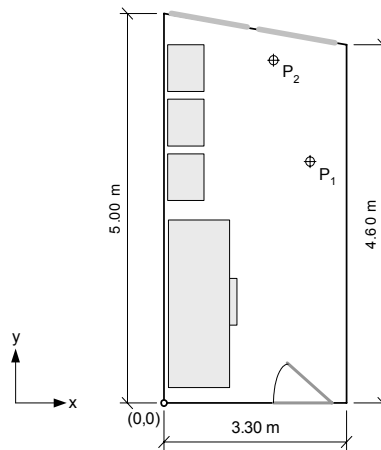

figure 12-12: Map of the points of measurement

table 12-5: Coordinates of the points of measurement

	x (cm)	y (cm)	z (cm)	x <sub>1</sub> (cm)	y <sub>1</sub> (cm)	z <sub>1</sub> (cm)
P1	195	307	86	-	-	106
P2	144	460	86			117

### 12.1.3 BEGF INSTALLATION

At the installation BEGF two measurements were performed: one indoor, 30 m from the antenna, another one outdoor, 140 m from the antenna.

table 12-6: Location of the BEGF installation

antenna	address	Zikadenweg 35, Bern-Galgenfeld
	acronym	BEGF
	longitude	N 46°57'24.84"
	latitude	E 07°28'17.29"
indoor point of measurement	address	Swisscom AG, Zikadenweg 35, Bern-Galgenfeld
outdoor point of measurement	address	(building Swisscom AG)

table 12-7: Technical data of the BEGF installation

cell ID	azimuth (°)	sector width (°)	SC	channel	f (MHz)	P <sub>CELL,max</sub> (dBm)	P <sub>CPICH</sub> (dBm)
BEGH1G	0	65	11	10588	2117.6	43	33(*)
BEGF2G	120	65	12	10588	2117.6	43	31(*)
BEGF3G	240	65	13	10588	2117.6	43	33(*)

(\*)36 dBm after 18:00 / 10.4.2003

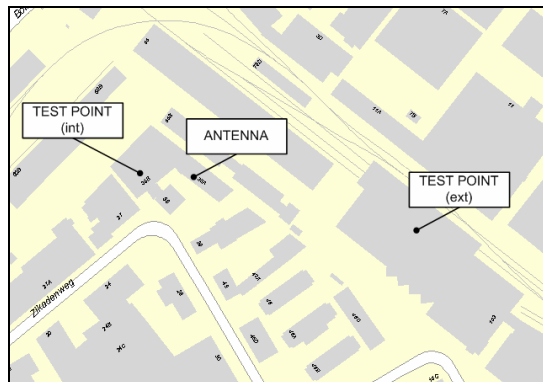

figure 12-13: Map of BEGF installation



figure 12-14: View of the BEGF installation



figure 12-15: View of the building where the indoor measurements were performed

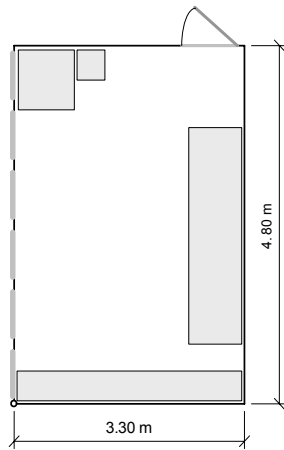

figure 12-16: Map of the room

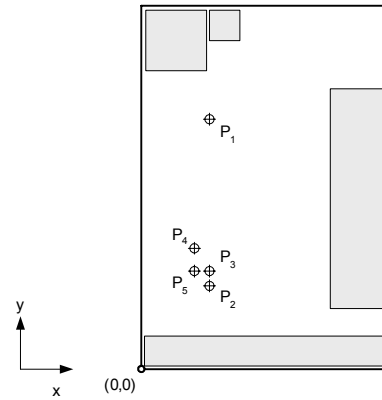

figure 12-17: Map of the indoor points of measurement

table 12-8: Coordinates of the indoor points of measurement

		x (cm)	y (cm)	z (cm)	x <sub>1</sub> (cm)	y <sub>1</sub> (cm)	z <sub>1</sub> (cm)
spectral and UMTS channel power measurements	P1	95	330	54	76	355	106
	P2	91	114	83	77	130	127
UMTS channel power and code domain measurements	P3	94	127	70	61	128	106
	P4	75	160	132	30	165	150
	P5	127	75	106	49	162	136



figure 12-18: View of an indoor point of measurement

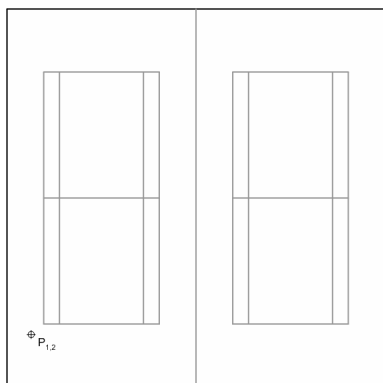

figure 12-19: Map of the outdoor points of measurement



figure 12-20: View of the outdoor point of measurement

table 12-9: Coordinates of the outdoor point of measurement

	Z (cm)	Z <sub>1</sub> (cm)
point 1	120	145
point 2	130	156

### 12.1.4 KONI INSTALLATION

At the installation KONI two locations were chosen for the measurements: one indoor, another one outdoor on the roof of the building (both around 120 m from the antenna).

table 12-10: Location of the KONI installation

antenna	address	Wabersackerstrasse 34, Köniz
	acronym	KONI
	longitude	N 46°55'46.20"
	latitude	E 07°25'30.14"
indoor point of measurement	address	Bundesamt für Gesundheit, Schwarzenburgstrasse 165, 3097 Liebefeld

table 12-11: Technical data of the KONI installation

cell ID	azimuth (°)	sector width (°)	SC	channel	f (MHz)	P <sub>CELL,max</sub> (dBm)	P <sub>CPICH</sub> (dBm)
KONI1G	0	65	171	10588	2117.6	43	27
KONI2G	130	65	172	10588	2117.6	43	27
KONI3G	240	65	173	10588	2117.6	43	27



figure 12-21: Map of KONI installation



figure 12-22: View of the KONI installation

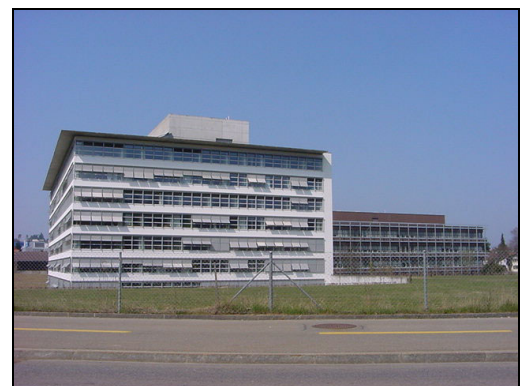

figure 12-23: View of the building where the indoor measurements were performed

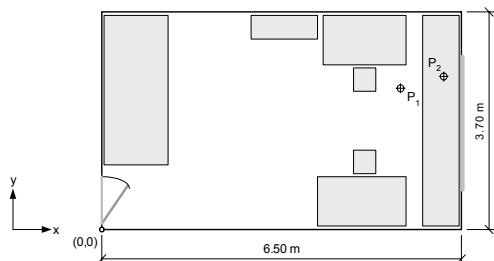

figure 12-24: Map of the indoor points of measurement



figure 12-26: View of the indoor points of measurement

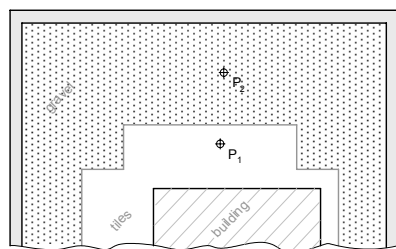

figure 12-25: Map of the outdoor points of measurement



figure 12-27: View of the outdoor points of measurement

table 12-12: Coordinates of the points of measurement

	x (cm)	y (cm)	z (cm)	x <sub>1</sub> (cm)	y <sub>1</sub> (cm)	z <sub>1</sub> (cm)
P1, indoor	540	240	120	585	280	135
P2, indoor	616	260	200	660	305	220
P1, outdoor	-	-	130	-	-	147
P2, outdoor	-	-	105	-	-	116



## 12.2 COMPARISON OF DIFFERENT MEASUREMENT INSTRUMENTS

### 12.2.1 PURPOSE

For each type of measurement two to six different measurement instruments were available. At many points of measurement several of these instruments were used sequentially. In this analysis, the results of measurements with different instruments are compared for each type of measurement separately. Results are only compared if the measurements were taken within two hours at the exactly same position and using the same receiving antenna. Since the UMTS test stations did not transmit any traffic channels, the UMTS signals are expected to be stable in intensity and the differences between instruments should therefore lie within their specified measurement accuracy.

### 12.2.2 TYPES OF MEASUREMENT

The following types of measurement were applied at three installations (ITTI, BEGF and KONI) at fixed points using the same measurement antenna :

- spectral power measurement with RBW=5 MHz (2 instruments);
- UMTS channel power measurement (4 instruments);
- CPICH power measurement (6 instruments).

With each instrument 4 to 6 values were measured at every point of measurement. These individual values were averaged. The averaged values of all instruments belonging to the same type of measurement were then compared and the difference between the maximum and minimum value (=variation range) was calculated. This comparison was done for each type of measurement separately.

For details of the individual measurements, please refer to appendix B1.

### 12.2.3 RESULTS

#### **COMPARISON OF DIFFERENT INSTRUMENTS FOR SPECTRAL POWER MEASUREMENTS (RBW=5 MHz)**

table 12-13: Instruments for spectral power measurements with RBW=5 MHz

Brand / Model	Measurement type / remarks	RBW (MHz)	Specified amplitude accuracy (dB)
instr#I	spectral power	5	± 1.5
instr#E	spectral power	5	± 0.5
R&S HE200 active antenna			

table 12-14: Comparison of spectral power measurements with RBW=5 MHz (ITTI and BEGF) - brief

Installation	Location	instr#I (dBm)	instr#E (dBm)	Variation range (dB)
ITTI	point 1	-30.49	-30.65	0.16
	point 2	-33.87	-33.89	0.02
BEGF	point 1, indoor	-22.67	-22.76	0.09
	point 2, indoor	-23.54	-23.54	0.00

The two instruments show excellent congruence. The results differ by less than 0.2 B.

**COMPARISON OF DIFFERENT INSTRUMENTS FOR UMTS CHANNEL POWER MEASUREMENTS**

table 12-15: Instruments for UMTS channel power measurements

Brand / Model	Measurement type / remarks	Specified amplitude accuracy (dB)
instr#C	UMTS channel power	± 1
instr#I	UMTS channel power (RBW 1 MHz)	± 1.5
	UMTS channel power (RBW 5 MHz)	± 1.5
instr#E	UMTS channel power	± 0.5
instr#D	UMTS channel power	± 0.2
R&S HE200 active antenna		

table 12-16: Comparison of UMTS channel power measurements (ITTI and BEGF) - brief

Installation	Location	instr#I	instr#I	instr#E	instr#D	instr#C	Variation range (dB)	Variation range without Advantest 5MHz (dB)
		RBW=1MHz (dBm)	RBW=5MHz (dBm)	(dBm)	(dBm)	(dBm)		
ITTI	point 1 indoor	-32.50	-33.36			-32.35	1.01	0.15
	point 2 indoor	-35.71	-36.95			-35.67	1.27	0.04
BEGF	point 1 indoor	-24.21	-25.41	-23.79		-24.20	1.62	0.42
	point 2 indoor	-25.13	-26.28	-24.33		-25.53	1.95	1.20
	point 3 indoor			-23.31		-24.51	1.20	1.20
	point 4 indoor			-26.37		-27.23	0.86	0.86
	point 5 outdoor			-23.29		-24.08	0.79	0.79
	point 2 outdoor			-24.14		-25.62	1.48	1.48
KONI	point 1 indoor				-55.47	-56.72	1.25	1.25
	point 2 indoor				-30.20	-31.00	0.80	0.80
	point 1 outdoor				-24.30	-24.99	0.69	0.69
	point 2 outdoor				-29.01	-29.55	0.54	0.54

The results of the three instruments differ by up to 2 dB if the measurements with the instr#I at RBW=5 MHz are included. If the latter data are excluded from the comparison, the variation reduces to 1.5 dB and therefore lies well within the accuracy specifications.

The results of the instruments instr#C and instr#E differ by up to 1.47 dB which is still within specification. For the pair instr#C / instr#D the maximum difference is 1.26 dB, slightly out of specification.

**COMPARISON OF DIFFERENT INSTRUMENTS FOR CODE DOMAIN MEASUREMENTS**

table 12-17: Instruments for code domain measurements

Brand / Model	Measurement type / remarks	Specified amplitude accuracy (dB)
instr#C	CPICH power	± 1
instr#I	CPICH power	± 1.5
instr#E	CPICH power	± 0.5
instr#D	CPICH power	± 0.2
instr#F	CPICH power	± 1.5
instr#H	CPICH power	± 2
R&S HE200 active antenna		

For each location the CPICH power values of each scrambling code (SC), on which the instrument was able to synchronize, are reported (table 12-18).

table 12-18: Comparison of CPICH power measurements - brief

SC	Location	instr#C (dBm)	instr#F (dBm)	instr#D (dBm)	instr#E (dBm)	instr#H (dBm)	instr#I (dBm)	Variation range (dB)	Variation range without instr#F (dB)
KONI 173	point 1 indoor	-60.51	-68.69	-60.53				8.18	0.02
	point 2 indoor	-34.10	-42.12	-34.66		-33.50		8.62	1.16
	point 1 outdoor	-27.80	-34.08	-28.24		-29.25		6.28	1.45
	point 2 outdoor	-32.80	-39.91	-32.70		-32.12		7.79	0.68
171	point 1 indoor	-64.00	-70.99	-64.29				6.99	0.29
	point 2 indoor	-43.62		-43.80		-42.73		1.07	1.07
BEGF 13	point 3 indoor	-26.90			-27.21		-27.43	0.53	0.53
	point 4 indoor	-30.46			-30.29		-31.01	0.72	0.72
	point 5 indoor	-27.20			-27.20		-27.68	0.48	0.48
11	point 4 indoor	-37.62			-37.17			0.45	0.45
	point 5 indoor	-34.22			-34.15			0.07	0.07
12	point 1 outdoor	-28.03			-28.06			0.03	0.03

The results of the six instruments differ by up to 8.6 dB, far beyond specifications.

The instr#F gives values which are systematically about 7 - 8 dB smaller than the other instruments. This deviation was reported to the manufacturer. This problem was detected not only during on-site measurements, but also during the laboratory measurements: in the latter case however the values obtained with the instr#F were about 3 dB higher than those of other instruments.

If the results of the instr#F are excluded from the above comparison, the variation range reduces to less than 1.5 dB and lies within specifications.

#### 12.2.4 CONCLUSIONS

The above comparisons show that for each of the three types of measurement the variation between different instruments is less than 1.5 dB and lies within the specified accuracy of the instruments.

Only with instr#F, which gives values too low by about 7-8 dB, a systematic error was detected. The manufacturer has been informed.

## 12.3 MEDIUM TERM REPRODUCIBILITY OF THE *SCHWENKMETHODE*

### 12.3.1 PURPOSE

In this chapter repeated measurements with the *Schwenkmethode*, spanning several days, at the same location by the same person using the same instrumentation are compared. The results provide quantitative information about the medium term stability of UMTS signals and the reproducibility of the *Schwenkmethode* when performed by the same person under realistic on-site conditions. Indications of short term reproducibility can be found in chapter 12.7.

### 12.3.2 METHOD

Repeated measurements were made at the same location on two or more consecutive days whereby several individual measurements were consecutively taken on each day: the time of the measurement sessions is specified for all days.

The transmitted power of the UMTS installations was constant (no traffic) with one exception where it was intentionally enhanced on one day. The procedure applied was the *Schwenkmethode*. Variations of the results within a time series can be due to changes of the field pattern at the location of measurement, fundamental limitations of the *Schwenkmethode* to detect the local maximum and meteorological influences on wave propagation.

Repeated measurements were performed at all four locations (BEFH, ITTI, BEGF and KONI). At every location four types of measurement (broadband, spectral power, UMTS channel power and CPICH power) were applied. The results are presented location by location.

The analysis is done in three steps:

- 2 to 3 consecutive measurements taken on the same day are characterized by their variation range, i.e. the difference between minimum and maximum measured on one measurement session;
- repeated measurements spanning several days are characterized by their overall variation range (difference between minimum and maximum), the mean value and the standard deviation of all individual measurements of the time series (see formula 12.2);
- finally the calculated standard deviations are pooled for all measurements of the same type in order to obtain an overall indication of the reproducibility of the respective type of measurement.

The mean value  $\bar{x}_j$  and the standard deviation  $s_j$  of all measurements taken at one location  $j$  by the same type of measurement are given by:

$$\bar{x}_j = \frac{1}{n_j} \sum_{i=1}^n x_{ij} \quad (12.1)$$

with  $i$  as sequence number,  $x$  as measured value, and  $n_j$  as number of measured values in one location  $j$ .

$$s_j = \sqrt{\frac{1}{n_j - 1} \sum_{i=1}^n (x_{ij} - \bar{x}_j)^2} \quad (12.2)$$

The deviation  $d_{ij}$  from the mean value is defined by:

$$d_{ij} = |\bar{x}_j - x_{ij}| \quad (12.3)$$

Since all measurement results and the above statistical parameters are on a log scale (dB), all deviations  $d_{ij}$  are relative ones and may be pooled without further normalization. In this way all individual results obtained with one type of measurement at the different locations are aggregated to the overall standard deviation  $s$  of a single type of measurement as follows:

$$s = \sqrt{\frac{1}{n} \sum_j \sum_{i=1}^{n_j} d_{ij}^2} \quad (12.4)$$

with  $n$  being the number of all the individual measurements of the respective type of measurement at all locations  $j$ .

### 12.3.3 REPRODUCIBILITY AT BEFH

table 12-19: Environmental conditions - BEFH

Date	02.apr	03.apr	04.apr	10.apr	17.apr
Weather	rainy	cloudy	sunny	variable	sunny
Time	08:30 18:50	09:30	08:30	19:25	18:25
Temperature	7.5° 7.7°	7.2°	16.2°	7.8°	20.4°

Measurements at the BEFH installation were performed on three consecutive days and on two other days, each one week apart. The point of measurement was outdoor.

The results of the spectral power measurements performed with the instr#G are shown in histograms 12-1 and 12-2.

The results of the UMTS channel power measurements performed with instr#C are shown in histograms 12-3 and 12-4.

The results of the CPICH power measurements performed with instr#C are shown in histograms 12-5 and 12-6.

For each type of measurement, the first histogram shows the individual power levels measured, while the second one shows the daily variation range (refer to tables in appendix B2.1 for details).

**SPECTRAL POWER MEASUREMENTS WITH INSTR#G, RBW 1MHZ**

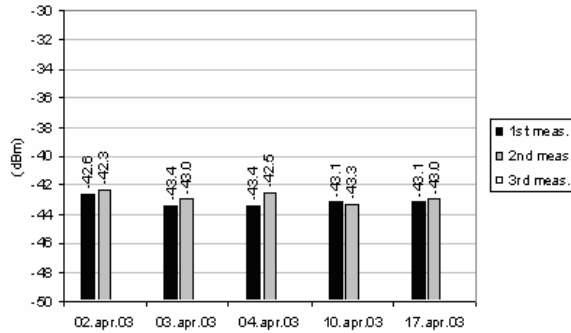

Histogram 12-1: Measurements

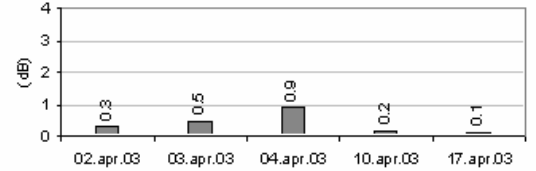

Histogram 12-2: Variation range on single days

**UMTS CHANNEL POWER MEASUREMENTS WITH INSTR#C**

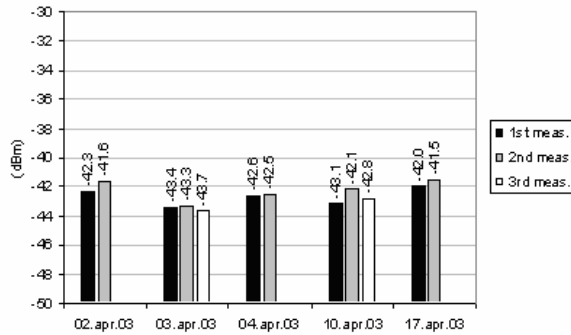

Histogram 12-3: Measurements

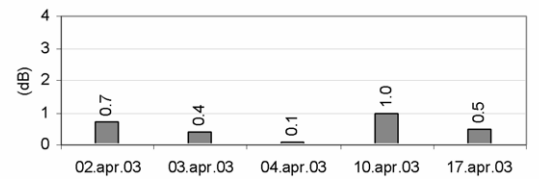

Histogram 12-4: Variation range on single days

**CPICH POWER MEASUREMENTS WITH INSTR#C**

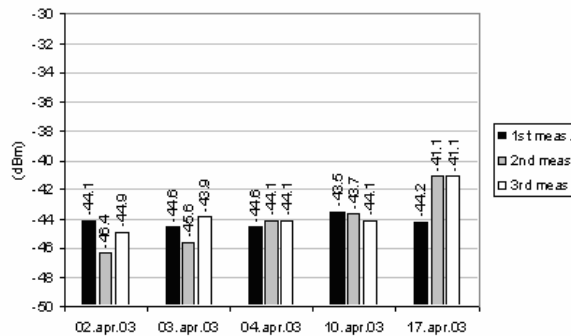

Histogram 12-5: Measurements

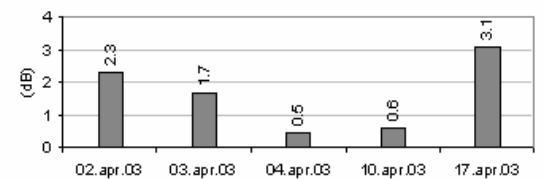

Histogram 12-6: Variation range on single days



**BEFH - REPRODUCIBILITY CONCLUSIONS**

table 12-20: Summary of reproducibility measurements – at BEFH

measurement	mean value (dBm)	standard deviation (dB)	variation range (dB)	maximal variation range at a single day (dB)
Spectral power	-42.97	0.39	1.14	0.89
UMTS channel power	-42.58	0.71	2.20	1.00
CPICH power	-44.00	1.39	5.30	3.10

The results of the reproducibility measurements at BEFH are summarized in table 12-20.

Reproducibility is good for spectral and UMTS channel power measurements, it is worse for CPICH power measurements. The relatively poor performance of code domain measurements can be attributed to the fact that the absolute power level was almost 20 dB below that measured at the other installations, which may have made it difficult for the instrument to reliably synchronize to the CPICH.

It should be emphasized that the measurements in this time series were performed under variable environmental conditions and separated in time by as much as two weeks.

### 12.3.4 REPRODUCIBILITY AT ITTI

table 12-21: Environmental conditions - ITTI

Date	02.apr.03	03.apr.03	04.apr.03
Weather	rainy	cloudy	sunny
Time	11:00	11:00	10:00
Temperature	12.4°	16.7°	13.2°

Measurements at the ITTI installation were performed on three consecutive days. The point of measurement was indoor.

The results of the spectral power measurements performed with the instr#G are shown in histograms 12-7 and 12-8.

The results of the UMTS channel power measurements performed with instr#G are shown in histograms 12-9 and 12-10.

The results of the CPICH power measurements performed with instr#G are shown in histograms 12-11 and 12-12.

For each type of measurement, the first histogram shows the individual power levels measured, while the second one shows the daily variation range (refer to tables in appendix B2.2 for details).

**SPECTRAL POWER MEASUREMENTS WITH INSTR#G, RBW 1MHz**

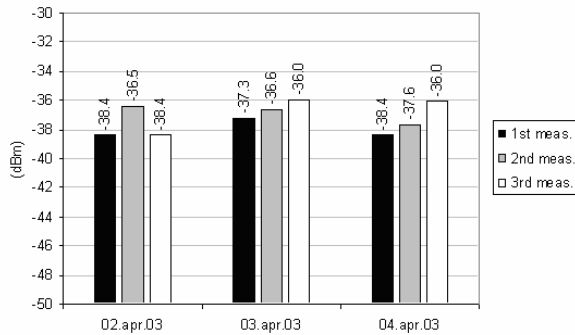

Histogram 12-7 Measurements

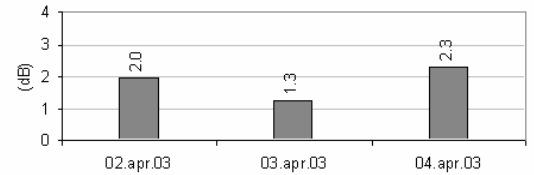

Histogram 12-8: Variation range on single days

**UMTS CHANNEL POWER MEASUREMENTS WITH INSTR#C**

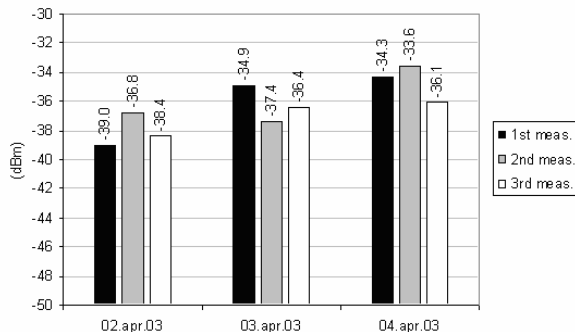

Histogram 12-9: Measurements

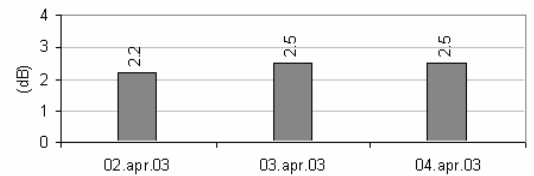

Histogram 12-10: Variation range on single days

**CPICH POWER MEASUREMENTS WITH INSTR#C**

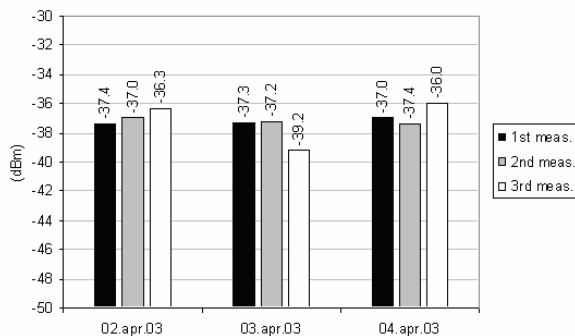

Histogram 12-11: Measurements

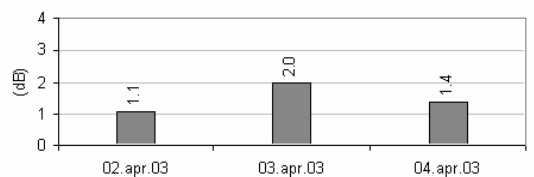

Histogram 12-12: Variation range on single days

**ITTI - REPRODUCIBILITY CONCLUSIONS**

table 12-22: Summary of reproducibility measurements – at ITTI

measurement	mean value (dBm)	standard deviation (dB)	variation range (dB)	maximal variation range at a single day (dB)
Spectral power	-37.24	1.01	2.44	2.32
UMTS channel power	-36.32	1.82	5.40	2.50
CPICH power	-37.20	0.90	3.20	2.00

The results of the reproducibility measurements at ITTI are summarized in table 12-22.

Reproducibility at this installation is worse than at all the other installations. This may be due to the fact that the antenna was 400 m remote and the measurements were performed under very different environmental conditions (hail, rainy, or sunny), which may have noticeably influenced the wave propagation.

### 12.3.5 REPRODUCIBILITY AT BEGF

table 12-23: Environmental conditions BEGF

Date	09.apr.03	10.apr.03	11.apr.03
Weather	snowy/rainy	rainy	sunny
Time	10:00	09:20	08:30
Temperature	19°	20.5°	17°

Measurements at the BEGF installation were performed on three consecutive days. The point of measurement was indoor.

The results of the spectral power measurements performed with the instr#G are shown in histograms 12-13 and 12-14.

The results of the UMTS channel power measurements performed with instr#C are shown in histograms 12-15 and 12-16.

The results of the CPICH power measurements performed with instr#C are shown in histograms 12-17 and 12-18.

For each type of measurement, the first histogram shows the individual power levels measured, while the second one shows the daily variation range (refer to tables in appendix B2.3 for details).

**SPECTRAL POWER MEASUREMENTS WITH INSTR#G, RBW 1MHZ**

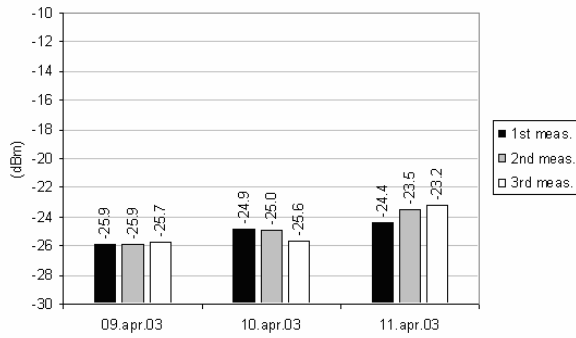

Histogram 12-13 Measurements

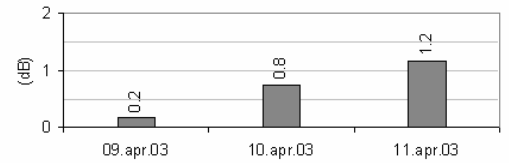

Histogram 12-14: Variation range on single days

**UMTS CHANNEL POWER MEASUREMENTS WITH INSTR#C**

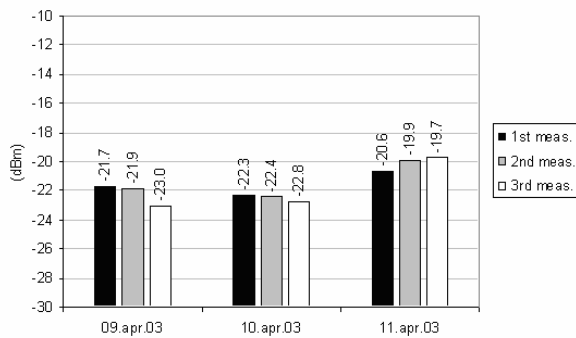

Histogram 12-15: Measurements

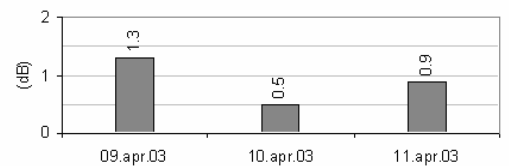

Histogram 12-16: Variation range on single days

**CPICH POWER MEASUREMENTS WITH INSTR#C**

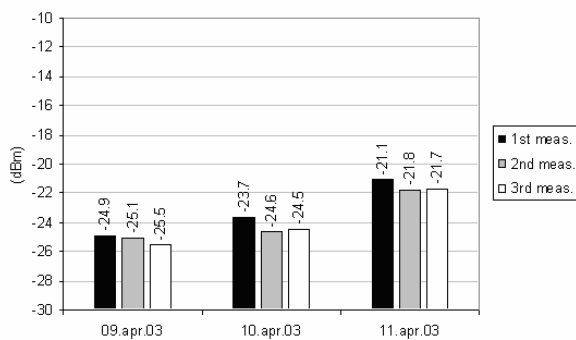

Histogram 12-17: Measurements

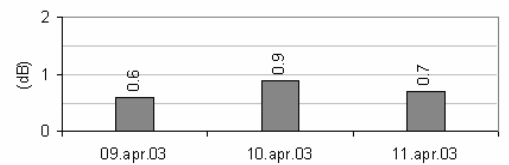

Histogram 12-18: Variation range on single days

**BEGF - REPRODUCIBILITY CONCLUSIONS**

table 12-24: Summary of reproducibility measurements – at BEGF

measurement	mean value <sup>1)</sup>	standard deviation <sup>1)</sup>	variation range <sup>1)</sup>	maximal variation range at a single day
	(dBm)	(dB)	(dB)	(dB)
Spectral power	-25.49	0.46	1.04	1.17
UMTS channel power	-22.35	0.50	1.30	1.30
CPICH power	-24.72	0.61	1.80	0.90

1) Only measurements of 9. and 10.4.2003 included.

The results of the reproducibility measurements at BEGF are summarized in table 12-24.

Between April 10 and 11 the transmitted power of BEFH was intentionally increased. For the measured cell (SC = 13) the power increase was 3 dB. Because of this change of the operational conditions during the measurement series only the data obtained on April 9 and 10 were included in the statistical analysis. Reproducibility is good for all three types of measurement, the standard deviation being less than 0.6 dB.

It is interesting to analyze how accurately the increase in transmitted power is reflected in the measured field strengths. In table 12-25 the measured powers are compiled for the two operational conditions. For the CPICH power the difference is 3.16 dB, in excellent agreement with the actual power increase of 3 dB. The spectral and the UMTS channel power measurements on the other hand seem to somewhat less reliably detect the power increase.

table 12-25: Influence of an increase of transmitted power on measured power levels (mean values)

Measurement	Spectral power	UMTS channel power	CPICH power
	(dBm)	(dBm)	(dBm)
April 9 and 10	-25.49	-22.35	-24.68
April 11	-23.70	-20.07	-21.52
<b>Difference</b>	<b>1.78 dB</b>	<b>2.28 dB</b>	<b>3.16 dB</b>

## 12.3.6 REPRODUCIBILITY AT KONI

table 12-26: Environmental conditions - KONI

Date	16.apr	17.apr
Weather	sunny	sunny
Time	13:15	08:50
Temperature	27.5°	25.1°

Measurements at the KONI installation were performed on two consecutive days. The point of measurement was indoor.

The results of the spectral power measurements performed with the instr#G are shown in histograms 12-19 and 12-20.

The results of the UMTS channel power measurements performed with instr#C are shown in histograms 12-21 and 12-21.

The results of the CPICH power measurements performed with instr#C are shown in histograms 12-23 and 12-24.

For each type of measurement, the first histogram shows the individual power levels measured, while the second one shows the daily variation range (refer to tables in appendix B2.4 for details).



**SPECTRAL POWER MEASUREMENTS WITH INSTR#G, RBW 1MHz**

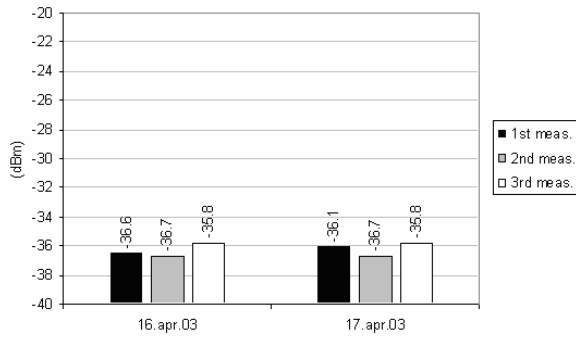

Histogram 12-19: Measurements

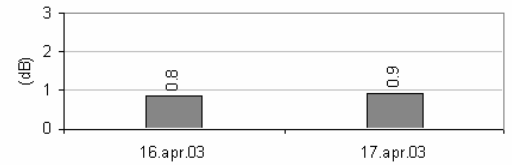

Histogram 12-20: Variation range on single days

**UMTS CHANNEL POWER MEASUREMENTS WITH INSTR#C**

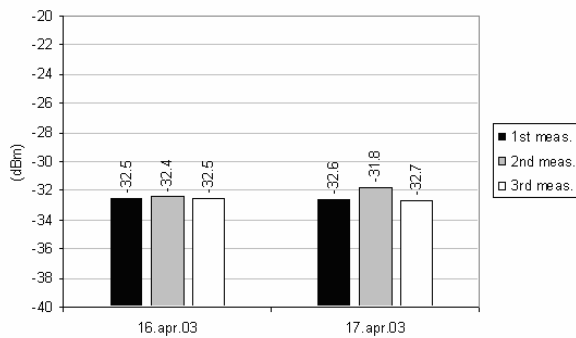

Histogram 12-21: Measurements

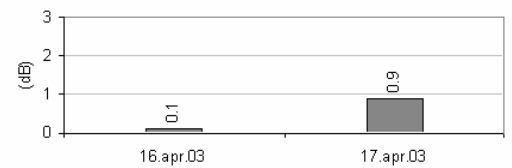

Histogram 12-22: Variation range on single days

**CPICH POWER MEASUREMENTS WITH INSTR#C**

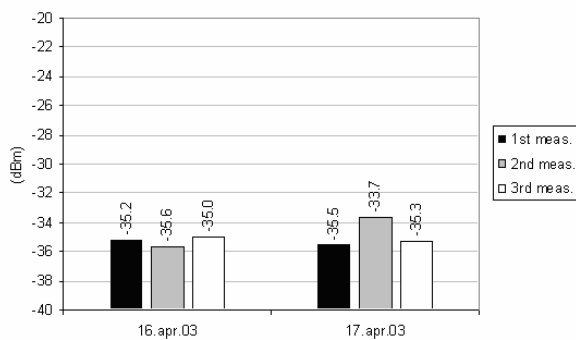

Histogram 12-23: Measurements

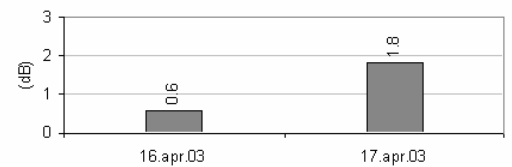

Histogram 12-24: Variation range on single days

**KONI – REPRODUCIBILITY CONCLUSIONS**

table 12-27: Summary of reproducibility measurements – at KONI

measurement type	mean value (dBm)	standard deviation (dB)	variation range (dB)	maximal variation range at a single day (dB)
Spectral power	-36.27	0.42	0.93	0.93
UMTS channel power	-32.42	0.32	0.90	0.90
CPICH power	-35.05	0.69	1.90	1.80

The results of the reproducibility measurements at KONI are summarized in table 12-27.

Reproducibility is good, the standard deviation being less and 0.7 B for all three types of measurement.

In this case measurements have been performed under stable environmental conditions.

### 12.3.7 OVERALL CONCLUSIONS ON REPRODUCIBILITY

table 12-28: Summary of standard deviations (dB)

	spectral power	UMTS channel power	CPICH power
BEFH	0.39	0.71	1.39
ITTI	1.01	1.82	0.90
BEGF	0.46	0.50	0.61
KONI	0.42	0.32	0.69
overall	<b>0.61</b>	<b>1.01</b>	<b>1.03</b>

In table 12-28 the standard deviations for each installation and type of measurement are summarized. These values are graphically represented by histograms 10-25 to 10-27 together with the absolute power levels. In addition, the overall standard deviation for each type of measurement was calculated according to formula (12.4). Values measured at BEGF after the power increase were excluded from this analysis.

Overall, the reproducibility of the *Schwenkmethode* for UMTS channel power and CPICH power measurements can be expected to be about  $\pm 1$  dB (standard deviation), for spectral power measurements it is even better. This result is valid for repeated measurements on different days by the same person using the same equipment and the same search procedure for detecting the local maximum.

Elevated standard deviations resulted for the code domain measurements at BEFH (probably because of weak signals) and at ITTI (high distance from the transmitter / variable environmental conditions). These measurements under difficult but still realistic conditions are included in the above overall estimate.

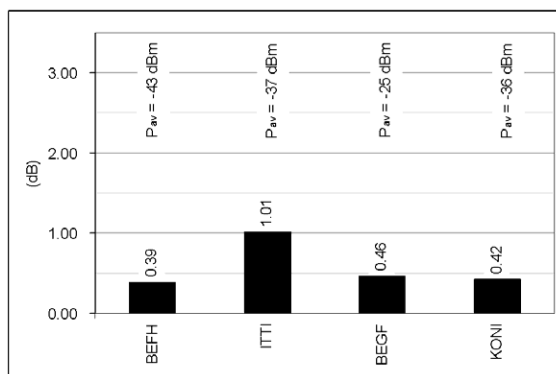

Histogram 12-25: Standard deviation – spectral power

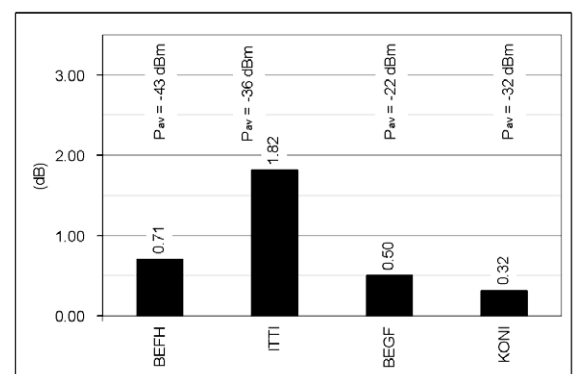

Histogram 12-26: Std. deviation – UMTS channel power

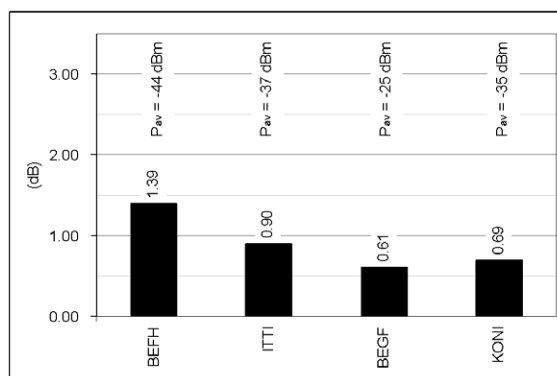

Histogram 12-27: Standard deviation – CPICH power

In table 12-29 the daily variation ranges are summarized. Generally they are lower than 2 dB (often close to 1 dB). As already mentioned for the standard deviations, larger variations were observed for code domain measurements at BEFH (probably because of weak signals) and at ITTI (high distance from transmitter / variable environmental conditions).

table 12-29: Summary of daily variation ranges

Installation	Measurement type	day 1	day 2	day 3	day 4	day 5
		(dB)	(dB)	(dB)	(dB)	(dB)
BEFH	spectral power	0.3	0.5	0.9	0.2	0.1
	UMTS channel power	0.7	0.4	0.1	1.0	0.5
	CPICH power	2.3	1.7	0.5	0.6	3.1
ITTI	spectral power	2.0	1.3	2.3		
	UMTS channel power	2.2	2.5	2.5		
	CPICH power	1.1	2.0	1.4		
BEGF	spectral power	0.2	0.8	1.2		
	UMTS channel power	1.3	0.5	0.9		
	CPICH power	0.6	0.9	0.7		
KONI	spectral power	0.8	0.9			
	UMTS channel power	0.1	0.9			
	CPICH power	0.6	1.8			

## 12.4 COMPARISON OF SPECTRAL MEASUREMENTS WITH DIFFERENT RESOLUTION BANDWIDTH

### 12.4.1 PURPOSE

If wideband signals are measured, the setting of the resolution bandwidth filter (RBW) of the spectrum analyzer influences the power value determined by the instrument (see L. Martens publications). Since a UMTS signal has a 5 MHz bandwidth, ideally a resolution bandwidth filter (RBW) of 5 MHz should be set in order to measure the whole channel power. Actually, many older spectrum analyzers allow only smaller resolution bandwidths (for instance 1 MHz).

As disclosed in chapter 7.1, one way to circumvent this limitation is the application of an empirical correction factor  $k_1$  to the measured value as outlined in formula (12.5) for power calculations and (12.6) for electrical field calculations:

$$P_{RBW=5MHz} [dBm] = P_{RBW=1MHz} [dBm] + k_{1,P} [dB] \quad (12.5)$$

$$E_{RBW=5MHz} [V/m] = E_{RBW=1MHz} [V/m] \cdot k_{1,E} [1] \quad (12.6)$$

Strictly speaking this correction factor has to be determined for each instrument individually by calibrating it with a UMTS signal of known power.

### 12.4.2 TYPES OF MEASUREMENT

The measurements were carried out in two locations, ITTI and BEGF. Two types of measurement were performed:

- Spectral power with RBW = 1 MHz (4 instruments),
- Spectral power with RBW = 5 MHz (2 instruments).

The antenna was fixed on a tripod. With each instrument/setting several measurements were taken and averaged. This procedure was repeated at several points of measurement.

### 12.4.3 RESULTS

The RBW = 5 MHz measurements have been performed by means of instr#E and instr#I. As the comparison between these two instruments (see chapter 12.3) showed that the measured values correspond in every measuring point, in the following comparison only the results of the instr#E instrument are included.

#### **ENVIRONMENTAL CONDITIONS AND USED INSTRUMENTS**

table 12-30: Environmental situation - ITTI

Date	02.apr.03	03.apr.03	04.apr.03
Weather	rainy	cloudy	sunny
Time	13:00	11:00	11:00
Temperature	10.5°	11.9°	13.9°

table 12-31: Environmental situation - BEGF

Date	09.apr.03	10.apr.03	11.apr.03
Weather	snowy / rainy	rainy	sunny
Time	-	-	-
Temperature	11.7°	13.8°	15.5°

table 12-32: Instruments and settings used

Brand / Model	Remarks	RBW (MHz)	Specified amplitude accuracy (dBm)
instr#G		1	± 2
instr#C	RBW cannot be set (depends directly on the span)	1	± 1
instr#I		1	± 1.5
		5	
instr#E		1	± 0.5
		5	
R&S HE200 active antenna			

**COMPARISON OF SPECTRAL POWER MEASUREMENTS WITH RBW=5 MHz AND RBW=1 MHz**

table 12-33: Comparison of spectral power measurements performed with RBW 1 MHz and RBW 5 MHz at ITTI and BEGF

Installation	Location	instr#E	instr#I			instr#E			instr#G			instr#C		
		RBW=5MHz (Reference) P (dBm)	RBW=1MHz			RBW=1MHz			RBW=1MHz			RBW=1MHz		
			P (dBm)	k <sub>1,P</sub> (dB)	k <sub>1,E</sub> (1)	P (dBm)	k <sub>1,P</sub> (dB)	k <sub>1,E</sub> (1)	P (dBm)	k <sub>1,P</sub> (dB)	k <sub>1,E</sub> (1)	P (dBm)	k <sub>1,P</sub> (dB)	k <sub>1,E</sub> (1)
ITTI	point 1 indoor	-30.65	-34.89	4.24	1.62	-34.78	4.13	1.61	-34.65	4.00	1.584	-31.5	0.85	1.10
	point 2 indoor	-33.89	-37.82	3.93	1.57	-37.98	4.09	1.60	-37.8	3.91	1.569	-34.5	0.61	1.07
BEGF	point 1 indoor	-22.76	-26.91	4.15	1.61	-27.22	4.46	1.67	-26.9	4.14	1.61			
	point 2 indoor	-23.55	-27.4	3.86	1.56	-27.92	4.38	1.65	-27.2	3.66	1.52			
	point 1 outdoor	-23.91				-27.89	3.98	1.58	-27	3.09	1.43			
Average				4.04	1.59		4.21	1.62		3.77	1.54		0.73	1.09

In table 12-33 the correction factors  $k_{1,P}$  and  $k_{1,E}$  to be used in formula (12.5) and (12.6) are tabulated.

**CONCLUSIONS**

The correction factors calculated for instr#I, instr#E and instr#G are of about 4 dB.

On the contrary, with instr#C instrument the results are very different ( $k_1 \approx 0.6 - 0.9$  dB). This difference may be attributed to the fact that this instrument is dedicated particularly to code domain measurements. Using the instrument as a spectrum analyzer, it is not possible to freely set RBW parameters. In order to obtain 1 MHz RBW a SPAN of 110 MHz had to be set, decreasing the measurement accuracy. Therefore it is not advisable to use this sort of instrument for this kind of comparison.

## 12.5 COMPARISON OF SPECTRAL AND UMTS CHANNEL POWER MEASUREMENTS

### 12.5.1 PURPOSE

The purpose of this section is to compare the results of spectral power and UMTS channel power measurements taken at the same points of measurement. Spectral measurements with a RBW of 5 MHz are taken as the reference.

### 12.5.2 TYPES OF MEASUREMENT

The measurements were carried out in two locations, ITTI and BEGF. Two types of measurement were performed:

- spectral power with RBW = 5 MHz (1 instrument);
- UMTS channel power (3 instruments).

The antenna was fixed on a tripod. With each instrument/setting several measurements were taken and averaged. This procedure was repeated at several points of measurement.

### 12.5.3 RESULTS

#### **ENVIRONMENTAL CONDITIONS AND USED INSTRUMENTS**

table 12-34: Environmental situation - ITTI

Date	02.apr.03	03.apr.03	04.apr.03
Weather	rainy	cloudy	sunny
Time	13:00	11:00	11:00
Temperature	10.5°	11.9°	13.9°

table 12-35: Environmental situation - BEGF

Date	09.apr.03	10.apr.03	11.apr.03
Weather	snowy / rainy	rainy	sunny
Time	-	-	-
Temperature	11.7°	13.8°	15.5°

table 12-36: Instruments and settings used

Brand/ Model	Measurement type	RBW (MHz)	Specified amplitude accuracy (dB)
instr#C	UMTS channel power		± 1
instr#I	UMTS channel power	1	± 1.5
	UMTS channel power	5	
instr#E	UMTS spectral power	5	± 0.5
	UMTS channel power	5	
R&S HE200 active antenna			



**COMPARISON OF SPECTRAL AND UMTS CHANNEL POWER MEASUREMENTS**

table 12-37: Comparison of spectral and UMTS channel power measurements at ITTI and BEGF

Installation Location	instr#E spectral power RBW=5MHz (reference) P (dBm)	instr#I UMTS channel power RBW = 1MHz		instr#I UMTS channel power RBW = 5MHz		instr#E UMTS channel power		instr#C UMTS channel power	
		P (dBm)	difference (dB)	P (dBm)	difference (dB)	P (dBm)	difference (dB)	P (dBm)	difference (dB)
ITTI	point 1 indoor	-30.65	-32.50 -1.86	-33.36 -2.71				-32.35 -1.70	
	point 2 indoor	-33.89	-35.71 -1.82	-36.95 -3.06				-35.67 -1.78	
BEGF	point 1 indoor	-22.76	-24.21 -1.45	-25.41 -2.65	-23.79 -1.03			-24.20 -1.44	
	point 2 indoor	-23.54	-25.13 -1.59	-26.28 -2.75	-24.33 -0.80			-25.53 -1.99	
	point 1 outdoor	-23.91						-25.71 -1.81	
<b>Average</b>			<b>-1.68</b>		<b>-2.79</b>		<b>-0.92</b>		<b>-1.75</b>

**CONCLUSIONS**

The UMTS channel power measured with the instruments instr#I (RBW = 1 MHz), instr#E and instr#C is 1 - 1.75 dB lower than the spectral power. The reason is, as explained in chapter 10, that spectral power measurements are of the peak type, whereas UMTS channel measurements are RMS type. The peak detector of the spectrum analyzer obviously overestimates the true signal power.

The UMTS channel power measured with the instrument instr#I at a RBW of 5 MHz is about 1 dB lower than when measured with a RBW of 1 MHz. This behavior is unexpected. A plausible explanation will be given as soon as possible by the Swiss retailer of instr#I.

## 12.6 COMPARISON OF CPICH POWER AND UMTS CHANNEL POWER MEASUREMENTS

### 12.6.1 PURPOSE

The purpose of this section is to compare the results of UMTS channel and CPICH power measurements taken at the same points of measurement. UMTS channel power is taken as the reference.

### 12.6.2 TYPES OF MEASUREMENT

Two types of measurement have been performed at three installations (ITTI, BEGF and KONI):

- UMTS channel power
- CPICH power. The three installations transmitted only common channels. Since no traffic channels were present, it is possible to calculate the total field strength of a cell by numerically adding a value of 1.91 dB to the measured CPICH power (see chapter 10.3).

The antenna was fixed on a tripod. With each instrument/setting several measurements were taken and averaged. This procedure was repeated at several points of measurement.

Measured and corrected values are presented in detail in appendix B.3.

In the results tables only the difference between UMTS channel power and corrected CPICH power (cell power) is presented. UMTS channel power is taken as the reference.

### 12.6.3 RESULTS

#### ***ENVIRONMENTAL CONDITIONS AND USED INSTRUMENTS***

table 12-38: Environmental conditions - ITTI

Date	04.apr.03
Weather	sunny
Time	11:00
Temperature	13.9°

table 12-39: Environmental conditions - BEGF

Date	10.apr.03	11.apr.03	11.apr.03 (outdoor)
Weather	rainy	sunny	sunny
Time	13:30	09:30	13:15
Temperature	13.8°	13°	12.8°

table 12-40: Environmental conditions - KONI

Date	02.apr.03	03.apr.03
Weather	sunny	sunny
Time	14:50	13:15
Temperature	13.8°	12.8°

table 12-41: Instruments used

Brand / Model	Measurement type	Specified amplitude accuracy (dB)
instr#C	UMTS channel power	± 1
	CPICH power	
instr#I	CPICH power	± 1.5
instr#E	UMTS channel power	± 0.5
	CPICH power	
instr#D	UMTS channel power	± 0.2
	CPICH power	
instr#F	CPICH power	± 1.5
instr#H	CPICH power	± 2
R&S HE200 active antenna		

**COMPARISON OF UMTS CHANNEL AND CPICH POWER MEASUREMENTS**

UMTS channel power was measured with the instr#C in all three locations and with either instr#E or instr#D in BEGF and KONI. For the measurements of CPICH power several instruments were used. In some locations the instruments were able to synchronize to more than one scrambling code and to measure the respective CPICH powers. In the following tables, the highlighted values represent evaluations by means of two scrambling codes. CPICH power has been corrected by the constant 1.91 dB to represent total cell power in the absence of any traffic.

table 12-42: Difference between UMTS channel power (instr#C) and the power of all common channels derived from CPICH measurements

Installation	Location	instr#C	instr#F	instr#E	instr#D	instr#H	instr#I
		(dB)	(dB)	(dB)	(dB)	(dB)	(dB)
ITTI	Point 1	-0.94					
BEGF	Point 3	-0.47		-0.79			-1.01
	Point 4	<b>-0.56</b>		<b>-0.34</b>			-1.87
	Point 5	<b>-0.42</b>		<b>-0.41</b>			-1.70
	Point 1 outdoor	-0.51		-0.53			
KONI	Point 1	<b>-0.30</b>	<b>-8.10</b>		<b>-0.37</b>		
	Point 2	<b>-0.73</b>	-9.22		<b>-1.26</b>	<b>-0.10</b>	
	Point 1 outdoor	-0.89	-7.19		-1.33	-2.34	
	Point 2 outdoor	-1.34	-8.74		-1.25	<b>-0.46</b>	

The table 12-42 shows the difference between the UMTS channel power measured with instr#C and the power of the common channels as calculated from CPICH power(s). In those cases where two scrambling codes could be detected, the power derived from the code domain measurement is about 0.5-1 dB lower than the UMTS channel power, while it is about 1-1.5 dB lower if only one scrambling code was detected.

table 12-43: Difference between UMTS channel power (instr#D and instr#E) and the power of all common channels derived from CPICH measurements

Installation	Location	instr#C	instr#F	instr#E	instr#D	instr#H	instr#I
		(dB)	(dB)	(dB)	(dB)	(dB)	(dB)
ITTI	Point 1						
BEGF	Point 3	-1.68		-2.00			-2.22
	Point 4	<b>-1.42</b>		<b>-1.20</b>			-2.73
	Point 5	<b>-1.21</b>		<b>-1.20</b>			-2.49
	Point 1 outdoor	-1.98		-2.00			
KONI	Point 1	<b>-1.54</b>	<b>-9.35</b>		<b>-1.62</b>		
	Point 2	<b>-1.53</b>	-10.02		<b>-2.06</b>	<b>-0.90</b>	
	Point 1 outdoor	-1.59	-7.89		-2.03	-3.04	
	Point 2 outdoor	-1.88	-9.28		-1.79	<b>-1.00</b>	

The table 12-43 shows the difference between the UMTS channel power, measured with the instr#D / instr#E and the power of the common channels as calculated from CPICH power(s). In those cases where two scrambling codes could be detected, the power derived from the code

domain measurement is about 1.5 dB lower than the UMTS channel power, while it is about 1.5 - 2 dB lower if only one scrambling code was detected.

In both comparison series the instr#F gives very different results: i.e. about 7-8 dB less than the other instruments. This systematic deviation was reported to the representative and to the manufacturer.

The detailed data of UMTS channel power, CPICH power and derived power of the common channels are available in the appendix B3.

#### 12.6.4 CONCLUSIONS

The comparisons presented in this section are justified only if the common channels alone are active. This requirement was fulfilled by the three investigated installations. UMTS channel power measurements should in this case ideally give the same result as the code domain measurements (after extrapolation from CPICH power to the power of all common channels). This equality can however only be expected if the code domain instruments detect all relevant CPICHs of the installation and maybe even of adjacent UMTS installations which are automatically captured by the UMTS channel power measurement systems. This condition was not met since only one or two CPICHs could be synchronized and measured. It is therefore to be expected that the code domain results are slightly lower than the UMTS channel powers. This is indeed found: code domain power is systematically lower than UMTS channel power:

- 0.5 to 1.5 dB if compared with UMTS channel power measured with instr#C;
- 1.5 to 2 dB if compared with UMTS channel power measured with instr#D and instr#E.

This systematic difference between the two types of measurement can be due to three factors: instrumental uncertainty; missing of some CPICHs in the code domain measurement; uncertainty of the extrapolation procedure from CPICH power to the power of all common channels. Given these sources of uncertainty the correspondence between the two types of measurement can be regarded as satisfactory.

In contrast the large systematic deviations found with instr#F are largely out of specifications and have to be clarified by the representative and the manufacturer.

## 12.7 SHORT TERM REPRODUCIBILITY OF THE *SCHWENKMETHODE*

### 12.7.1 PURPOSE

The purpose of this section is to investigate the suitability of the *Schwenkmethode* procedure under on-site conditions for the various types of measurement and instruments. The main objective of the *Schwenkmethode* is to find and measure the spatial maximum of the UMTS field strength within a given volume. In contrast to section 12.3, where *Schwenkmethode* measurements over several days are compared, the results presented here have been obtained by repeated measurements within a much shorter period, i.e. 2 hours. They therefore indicate the short term stability of the *Schwenkmethode*. In addition also the absolute values obtained for each of the types of measurement are compared.

### 12.7.2 TYPES OF MEASUREMENT

*Schwenkmethode* measurements were performed at the installations ITTI, BEGF and KONI using the following types of measurement:

- spectral power with RBW = 1MHz;
- spectral power with RBW = 5MHz;
- UMTS channel power;
- CPICH power.

*Schwenkmethode* measurements were conducted within a volume (radius < 0.7m) around a fixed position given by the tripod. The tripod had been previously positioned at a local maximum of the UMTS field strength as explained in chapter 12. Afterwards the *Schwenkmethode* was performed 4 to 6 times in series (about 2 minutes per individual measurement), the entire measurement volume being explored by changing simultaneously the direction and the polarization of the antenna. For each volume scan the maximum reading was recorded. From the individual measurement series the mean value and standard deviation were calculated.

Generally field strengths were found to be at maximum when the antenna was polarized at almost  $\pm 45^\circ$ .

## 12.7.3 RESULTS

**SPECTRAL AND UMTS CHANNEL POWER MEASUREMENTS**table 12-44: *Schwenkmethode* - instruments and settings used for spectral and UMTS channel power measurements at ITTI and BEGF

Brand / Model	Measurement type	RBW (MHz)	Specified amplitude accuracy (dB)
instr#G	spectral power	1	± 2
instr#C	UMTS channel power		± 1
instr#E	spectral power	1	± 0.5
	spectral power	5	
	UMTS channel power	5	
R&S HE200 active antenna			

table 12-45: *Schwenkmethode* - points of measurement for spectral and UMTS channel power measurements

Installation	Point of measurement
ITTI	Point 2 indoor
BEGF	Point 1 indoor
	Point 1 outdoor

table 12-46: ITTI point 2, indoor - brief (values in brackets are standard deviations of 4 individual measurements)

Instrument	<i>Schwenkmethode</i> measurement (dBm)	Fixed point measurement (dBm)	Difference (dB)
instr#G, spectral power	-37.33 (0.71)	-38.14 (0.25)	<b>0.82</b>
instr#C, UMTS channel power	-35.65 (0.40)	-35.68 (0.14)	<b>0.02</b>
instr#E, spectral power, RBW=1MHZ	-36.84 (0.24)	-38.08 (0.11)	<b>1.24</b>
instr#E, spectral power, RBW=5MHZ	-31.28 (0.79)	-33.89 (0.07)	<b>2.61</b>
		mean value (dB)	<b>1.17</b>
		std. deviation (dB)	<b>1.08</b>

table 12-47: BEGF point 1, indoor - brief (values in brackets are standard deviations of 4 to 6 individual measurements)

<b>Instrument</b>	<b>Schwenkmethode measurement (dBm)</b>	<b>Fixed point measurement (dBm)</b>	<b>Difference (dB)</b>
instr#G, spectral power	-26.43 (0.80)	-27.13 (0.20)	<b>0.70</b>
instr#C, UMTS channel power	-23.58 (0.41)	-24.20 (0.06)	<b>0.62</b>
instr#E, spectral power, RBW=1MHZ	-25.75 (0.74)	-27.32 (0.08)	<b>1.56</b>
instr#E, spectral power, RBW=5MHZ	-21.35 (0.98)	-22.76 (0.14)	<b>1.42</b>
instr#E, UMTS channel power, RBW=5MHZ	-23.18 (0.49)	-23.80 (0.17)	<b>0.62</b>
		<b>mean value (dB)</b>	<b>0.98</b>
		<b>std. deviation (dB)</b>	<b>0.47</b>

table 12-48: BEGF point 1, outdoor – brief (values in brackets are standard deviations of 6 individual measurements)

<b>Instrument</b>	<b>Schwenkmethode measurement (dBm)</b>	<b>Fixed point measurement (dBm)</b>	<b>Difference (dB)</b>
instr#G, spectral power	-26.45 (0.57)	-27.37 (0.28)	<b>0.92</b>
instr#C, UMTS channel power	-22.97 (0.23)	-25.72 (0.15)	<b>2.75</b>
instr#E, spectral power RBW=1MHZ	-25.40 (0.50)	-28.03 (0.13)	<b>2.63</b>
instr#E, spectral power RBW=5MHZ	-21.61 (0.40)	-23.91 (0.18)	<b>2.30</b>
		<b>mean value (dB)</b>	<b>2.15</b>
		<b>std. deviation (dB)</b>	<b>0.84</b>



**UMTS CHANNEL AND CPICH POWER MEASUREMENTS**table 12-49: *Schwenkmethode* - instruments used for UMTS channel and CPICH power measurements

Brand / Model	Measurement type	Specified amplitude accuracy (dB)
instr#C	channel power	± 1
	CPICH power	
instr#D	UMTS channel power	± 0.2
instr#E	UMTS channel power	± 0.5
instr#F	CPICH power	± 1.5
instr#H	CPICH power	± 2
R&S HE200 active antenna		

table 12-50: *Schwenkmethode* - points of measurement for UMTS channel and CPICH power measurements

Installation	Point of measurement
BEGF	point 3 indoor
	point 2 outdoor
KONI	point 1 outdoor

table 12-51: BEGF point 3, indoor - brief (values in brackets are standard deviations of 6 individual measurements)

Instrument	<i>Schwenkmethode</i> measurement (dBm)	Fixed point measurement (dBm)	Difference (dB)
instr#C, CPICH power, SC 13	-22.58 (0.93)	-26.90 (0.09)	4.32
instr#C, UMTS channel power	-20.12 (0.86)	-24.52 (0.31)	4.40
instr#E, UMTS channel power	-19.11 (0.91)	-23.31 (0.21)	4.21
		mean value (dB)	4.31
		std. deviation (dB)	0.10

table 12-52: BEGF point 2, outdoor - brief (values in brackets are standard deviations of 6 individual measurements)

Instrument	<i>Schwenkmethode</i> measurement (dBm)	Fixed point measurement (dBm)	Difference (dB)
instr#C, CPICH power, SC 12	-25.43 (0.26)	-28.03 (0.05)	2.60
instr#C, UMTS channel power	-23.25 (0.26)	-25.62 (0.04)	2.37
		mean value (dB)	2.48
		std. deviation (dB)	0.16

table 12-53: KONI point 1, outdoor - brief (values in brackets are standard deviations of 4 individual measurements)

Instrument	<i>Schwenkmethode</i> measurement (dBm)	Fixed point measurement (dBm)	Difference (dB)
instr#C, UMTS channel power	-25.28 (0.32)	-25.00 (0.24)	-0.27
instr#C, CPICH power, SC 173	-26.85 (0.33)	-27.80 (0.12)	0.95
instr#H, CPICH power, SC 173	-28.85 (0.21)	-29.25 (0.06)	0.40
instr#D, UMTS channel power	-23.97 (0.18)	-24.30 (0.14)	0.34
instr#F, CPICH power, SC 173	-34.83 (1.10)	-34.10 (0.45)	-0.73
		mean value (dB)	0.14
		std. deviation (dB)	0.65

For details of the individual measurements please refer to appendix B4.

## 12.7.4 CONCLUSIONS

The short term reproducibility of the *Schwenkmethode*, as quantified by the standard deviation of repeated measurements within 15 - 20 minutes, is generally less than 1 dB. For comparison, the standard deviation of repeated measurements at a fixed position is generally better than 0.3 dB. It can be concluded that the search for the spatial maximum introduces some additional variance which however is not alarming. Each of the four investigated types of measurement can be successfully applied in the *Schwenkmethode* procedure to reliably detect the spatial maximum of the UMTS field strength.

The absolute values of the different types of measurement at the same location are quite different. These differences follow the patterns already found and discussed in sections 12.4 to 12.6. The reasons for the systematic deviations have been given in these sections (influence of the RBW; peak versus RMS detector etc).

The comparison of the absolute values obtained with the *Schwenkmethode* with those at the fixed position shows that the former are generally higher (see table 12-54). This means that by sweeping through the volume a higher field strength value was detected than the local maximum at the position of the tripod. Ideally, at a given point of measurement, the difference between the *Schwenkmethode* and the fixed point measurement should be the same for each type of measurement. This is the case within a standard deviation of less than 1.1 dB as can be seen from table 12-55. There is no indication that any of the types of measurement deviates systematically. It can therefore be concluded that each of the four types of measurement is capable of detecting the spatial maximum of the UMTS field strength reliably if applied in the *Schwenkmethode* procedure.

table 12-54: Difference between *Schwenkmethode* and fixed point measurements - brief  
(reference: fixed point measurement)

	instr#G	instr#C	instr#C	instr#E	instr#E	instr#E	instr#D	instr#H	instr#F
	spectral power (dB)	UMTS channel power (dB)	CPICH power (dB)	spectral power RBW=1MHz (dB)	spectral power RBW=5MHz (dB)	UMTS channel power (dB)	UMTS channel power (dB)	CPICH power (dB)	CPICH power (dB)
ITTI, point 2, indoor	0.82	0.02		1.24	2.61				
BEGF, point 1, indoor	0.70	0.62		1.56	1.42	0.62			
BEGF, point 1, outdoor	0.92	2.75		2.63	2.30				
BEGF, point 3, indoor		4.40	4.32			4.21			
BEGF, point 2, outdoor		2.37	2.60						
KONI, point 1, indoor		-0.27	0.95				0.34	0.40	-0.73

table 12-55: Difference between *Schwenkmethode* and fixed point measurements, aggregated from table 12-54

	ITTI point 2 indoor	BEGF point 1 indoor 1	BEGF point 1 outdoor	BEGF point 3 indoor	BEGF point 2 outdoor	KONI point 1 outdoor
mean value (dB)	1.20	0.98	2.15	4.31	2.48	0.14
std. deviation (dB)	1.10	0.47	0.84	0.10	0.16	0.65

## 13 **SUMMARY AND CONCLUSIONS**

In the first phase of this project we characterized the UMTS air interface (UTRA). We explained the differences of the spectrum employment between the UMTS technology and the well-know GSM technology.

The UMTS air interface (UTRA) uses a wideband modulation WCDMA which requires a field strength measurement method which is different from those used with GSM signals. As a UMTS cell can use the same carrier frequency as another cell, the only way to separate the contributions of different cells is to decode the UMTS signal. Therefore instruments for code domain measurements are needed. Several instruments were evaluated and tested. Nonetheless are code domain measurements not the only way to measure UMTS signals. If not best accuracy is demanded, specifically if the field strength due to a UMTS installation is well below the installation limit value of the ordinance relating to protection from non-ionizing radiation, the following simpler methods may also be applied: spectral measurements with a conventional spectrum analyzer or a measurement with dedicated UMTS instruments which integrate the power within one UMTS channel without decoding the individual contributions. Both of these simpler methods are expected to yield higher field strengths than the code domain measurement which is considered as the reference.

The contracting authority required that the measurement method should correspond to the GSM method, particularly concerning the possibility of using the *Schwenkmethode* and of projecting the measured field strength value to the maximum allowed cell power. At the end of phase one, three measurement methods were proposed: one in the frequency domain which allows a rough appreciation of the field strength, another one in the code domain which allows the identification of the signals of individual cells, and an intermediate one (UMTS channel power) which performs an RMS measurement of one UMTS channel without discriminating between different cells.

The feasibility of these methods was tested and confirmed in the second phase of this work by laboratory and on-site measurements.

### ***LABORATORY MEASUREMENTS – PURPOSE***

The aim of these measurements was to find out whether the *Schwenkmethode* procedure was in principle suitable also for measurements in code domain and of UMTS channel power and how reliably it could detect the spatial maximum of the field strength distribution.

For this purpose a UMTS field was set up in a closed room in the laboratory and characterized in detail by mapping the field distribution. Afterwards, the *Schwenkmethode* was applied within this well defined electromagnetic environment. The *Schwenkmethode* measurements were performed with biconical and directional antennas and at different sweeping speeds and antenna polarizations.

### ***LABORATORY MEASUREMENTS – RESULTS***

The laboratory trials show that the *Schwenkmethode* is a reliable procedure to find and measure the field strength maximum in a given volume also for UMTS signals, both with code selective instruments and with instruments measuring UMTS channel power.

The basic procedure is the same as in GSM measurements. The antenna is moved through the whole volume under investigation while simultaneously aligning its direction and polarization. The antenna sweeping speed seems not particularly relevant for the detection of the maximum level.

The instruments should be equipped with “max hold” functions.

A survey time up to 6 - 8 minutes should be foreseen, in order to obtain high quality measurements. It is advisable to first identify the approximate location of the spatial maximum, and then to examine in detail only the immediate surrounding of this point.

**ON-SITE MEASUREMENTS – PURPOSE**

After it had been shown in the laboratory that UMTS signals can be measured and that the *Schwenkmethode* is applicable, a confirmation of these findings was attempted out of the laboratory in the vicinity of real UMTS stations. At this time none of the four Swiss UMTS networks had started routine operation. However, Swisscom already operated a test network in Bern of which four transmitting installations were chosen for on-site measurements. These installations carried no traffic in this time period. They emitted only the common channels at a constant power. All three proposed types of measurement - spectral power, UMTS channel power and CPICH power - were extensively tested with several instruments. Measurements were performed indoor and outdoor. The same situation was measured with several instruments thus enabling quantitative comparisons among instruments of the same type of measurement and also between the three types. Repeated measurements of the same situation, either short term or medium term (spanning several days) allow to assess the reproducibility of the measurement methods and the stability of the exposure. Particular efforts were taken to quantify the reproducibility of the *Schwenkmethode* and its ability to detect the spatial field strength maximum under real life conditions.

**ON-SITE MEASUREMENTS – COMPARISON OF DIFFERENT INSTRUMENTS**

Different instruments of the same type - either spectral power, UMTS channel power or CPICH power - generally yield consistent results for the same situation. Differences between instruments are less than 1.5 dB and lie within specifications. Only with the measurement system instr#F a problem was discovered: the values measured with this system were systematically about 7-8 dB lower than the values of the other instruments.

The code domain measurements on this test network showed a common problem: because of weak signals almost all the instruments could not synchronize on all three scrambling codes of an installation. Only the instr#H succeeded in synchronizing on all the installation's codes: this instrument is therefore specifically suited to measure weak signals.

**ON-SITE MEASUREMENTS – REPRODUCIBILITY**

In order to observe the signal stability and assess the reproducibility of the measurement methods, repeated measurements were performed with the *Schwenkmethode* on different installations for several days. For each type of measurement - spectral power, UMTS channel power and P\_CPICH power - the standard deviation was calculated. The standard deviation is 0.61 dB for spectral power measurements and about 1 dB for UMTS power and CPICH power measurements. Taking into account that these measurements spanned several days including different meteorological conditions this stability can be considered good, both for the UMTS emission as well as for the detection methods.

**ON-SITE MEASUREMENTS – SPECTRAL MEASUREMENTS WITH DIFFERENT RESOLUTION BANDWIDTH**

Many spectrum analyzers do not yet provide a resolution bandwidth (RBW) of 5 MHz which is needed for the correct measurement of the power of a UMTS signal in frequency domain. Rather, their maximum RBW is limited to 1 MHz. In order to quantify the difference between the two RBWs, the same situation was measured with 1 and 5 MHz RBW. Measurements with a RBW of 1 MHz were found to be about 4 dB too low. This empirical finding can be used in the future to approximately correct measurements taken with a RBW of 1 MHz.

**ON-SITE MEASUREMENTS – COMPARISON OF DIFFERENT TYPES OF MEASUREMENT**

Three types of measurement were carried out at the same locations: spectral power, UMTS channel power and CPICH power measurements. Because no traffic channels were active during the measurements a quantitative comparison is permitted. Before the results can be compared, however, the measured CPICH power needs to be extrapolated to include all common channels transmitted. This is accomplished by adding a constant of 1.91 dB which is specific for the Swisscom test network. The comparison between the three measurement types reveals the following:

- Results of UMTS channel measurements are generally lower than spectral power measurements by up to 1.75 dB. The reason is probably the different power detectors applied in these instruments. Spectrum analyzers use peak detectors while dedicated instruments for the measurement of UMTS channel power use RMS detectors.
- The power of all common channels as derived from a CPICH power measurement is generally 0.5 to 2 dB lower than the corresponding UMTS channel power. This difference is not fully explained. It may among other factors be due to the fact, that the UMTS channel power automatically includes contributions of all cells of the same carrier frequency while the code domain method misses some (though weak) CPICHs to which the instruments could not synchronize.

**ON-SITE MEASUREMENTS – VALIDATION OF THE SCHWENKMETHODE**

Repeated performance of the *Schwenkmethode* procedure at the same location showed that the spatial maximum of the field strength can be reproducibly detected with a standard deviation of 1.1 dB. Each of the three types of measurement can be successfully applied in the *Schwenkmethode* procedure.

**ADVICES – FEASIBILITY OF THE SCHWENKMETHODE**

The body of the measurements conducted so far shows that the *Schwenkmethode* can be applied to UMTS signals.

Longer sweeping time in comparison with the GSM measurements are advisable (6-8 minutes), i.e. staying longer particularly where a local maximum is detected. In addition it is recommended to sweep with the antenna in all polarizations and directions. To reduce the measurement time, instruments with high speed data acquisition are particularly suitable.

**ADVICES – ELECTRIC FIELD EXTRAPOLATION TO THE MAXIMUM AUTHORIZED POWER**

The P\_CPICH can be considered as stable. Therefore, as for GSM, an extrapolation (*Hochrechnung*) of the field strength to the maximum cell power is possible. The projection can be calculated with a fixed factor  $k$ , which is the square root of the ratio between CPICH power and the maximum authorized cell power.

In the code domain, this projection can be done for each cell individually thus leading to the most realistic final result.

In the frequency domain - for spectral power as well as for UMTS channel power measurements - the extrapolation tends to overestimate the maximum field strength produced by the installation at its maximum authorized power. If the extrapolated value is below the installation limit value, compliance is demonstrated. If it exceeds the installations limit value a final assessment cannot be made. Instead a code domain measurement should follow.

**ADVICES – USE OF SPECIAL TEST SIGNALS**

A special operational state of the installation (*Sonderbetrieb*) in order to make the measurement easier is not necessary. Our measurements have demonstrated that high quality results can be obtained during the regular operation of the network.

**RECOMMENDATIONS**

When the UMTS network will be operative, we recommend that an extensive measurement series is performed again in order to validate the reproducibility and CPICH stability also under conditions of realistic network traffic.

In order to determine the influence of the operator and of equipment, we suggest to perform a inter-laboratory comparison campaign at some installations.

## 14 THANKS

This project was achieved with the interaction of many people and organizations. To them I express my warmest thanks.

Particularly, I would like to thank the Swiss Agency for the Environment, Forests and Landscape (SAEFL - BUWAL) for entrusting us with this project and giving adequate financial support. I would like to mention here that Dr. Bruno Oberle, vice director of BUWAL, Dr. Jürg Baumann, head of BUWAL's NIS section and Dr. Andreas Siegenthaler, BUWAL's manager of the present project, did not spare in helping us in the organization and have been always cooperating in real terms.

In addition, for the success of the study, the following persons and companies have put at our disposal knowledge and logistic infrastructures:

METAS, Swiss Federal Office of Metrology and Accreditation, particularly Eng. Kurt Hilty, Eng. Heinrich Ryser, Eng. Beat Mühlemann;

SUNRISE AG, TDC Switzerland, Dir. Manfred Speckert, Dr. Michael Burkhardt, Eng. Fritz Landolt;

SWISSCOM AG, Dir. Claude Georges, Eng. Bernhard Eicher, Eng. Peter Fritschi;

TIM, Italy, Eng. Flavio Buscaglia;

BAG, Mr. Martin Meier, Ms. Franziska Reidhaar;

Prof. Dr. Mathias Wuschek, Fachhochschule Deggendorf, Germany

Prof. Dr. Luc Martens, Gent University, Belgium

ANFR France, Mr. F.Couturier, Mr. JB. Agnani

JRC Ispra - I, Dr. Demosthenes Papameletiou

Furthermore, I would like to thank the following companies of measuring instruments and their representatives, who have placed at our disposal all the available measurement instruments, supplying also advices and demonstrations.

Emitec, CH - Cham; Mr. Armin Diethelm (Agilent), Eng. Patrick Janett (PMM);

ROSCHI, CH - Ittigen; Mr. Markus Haymoz (R&S and Advantest), Mr. Peter Bichsel (Tektronix);

Exanovis, CH - Schönbühl, Mr. Stefan Junker (Anritsu);

Orange Communications SA, CH - Lausanne , Mr. Lam Anthony (Anritsu Area tester);

Agilent, I – Milan/Rome; Mr. Mauro Loprieno, Mr. Mauro Coghetto, Mr. Stefano Bacchini;

Tektronix, I - Milan, Mr. Maurizio Mastrofini;

Anritsu, GB - Luton; Mr. Michael Spartny;

Last but not least, a particular thank goes to Swisscom Mobile AG for providing their UMTS test network, needed for all the on-site measurements.

Andrea Salvadè

SUPSI - DTI

## 15 **BIBLIOGRAPHY**

- [1] WCDMA for UMTS – Radio Access for third generation Mobile Communications  
Harry Holma, Antti Toskala, Wiley 2000
- [2] Introduction to 3G mobile communications  
Juha Korhonen, Artech House, Boston – London 2001
- [3] Techniques for measuring UMTS signals emitted by radio base stations  
Flavio Buscaglia, Telecom Italia Lab
- [4] First experiences with electromagnetic measurements around UMTS base stations  
L. Martens, C. Olivier, W. Joseph, Ghent University
- [5] “Scheda informativa” UMTS  
BAKOM, 14 December 2000
- [6] Mobilfunk-Basisstationen (GSM) - Messempfehlung  
BUWAL, 2002
- [7] Exposure assessment around UMTS base stations, extension of existing measuring procedures  
C. Olivier, L. Martens, Ghent University